

Eerste verdieping



Achtergevel schaal 1:100



STEENBRUGGE  
DEVENTER



Samenvoegen  
berging bij wnk

Tekening: \_\_\_\_\_

Woningtype: E60

Bouwnummer: -

Optienummer: 1.A.E.14

Bladformaat: A3

Schaal: 1:50 / 1:100

Datum: 26-11-2024

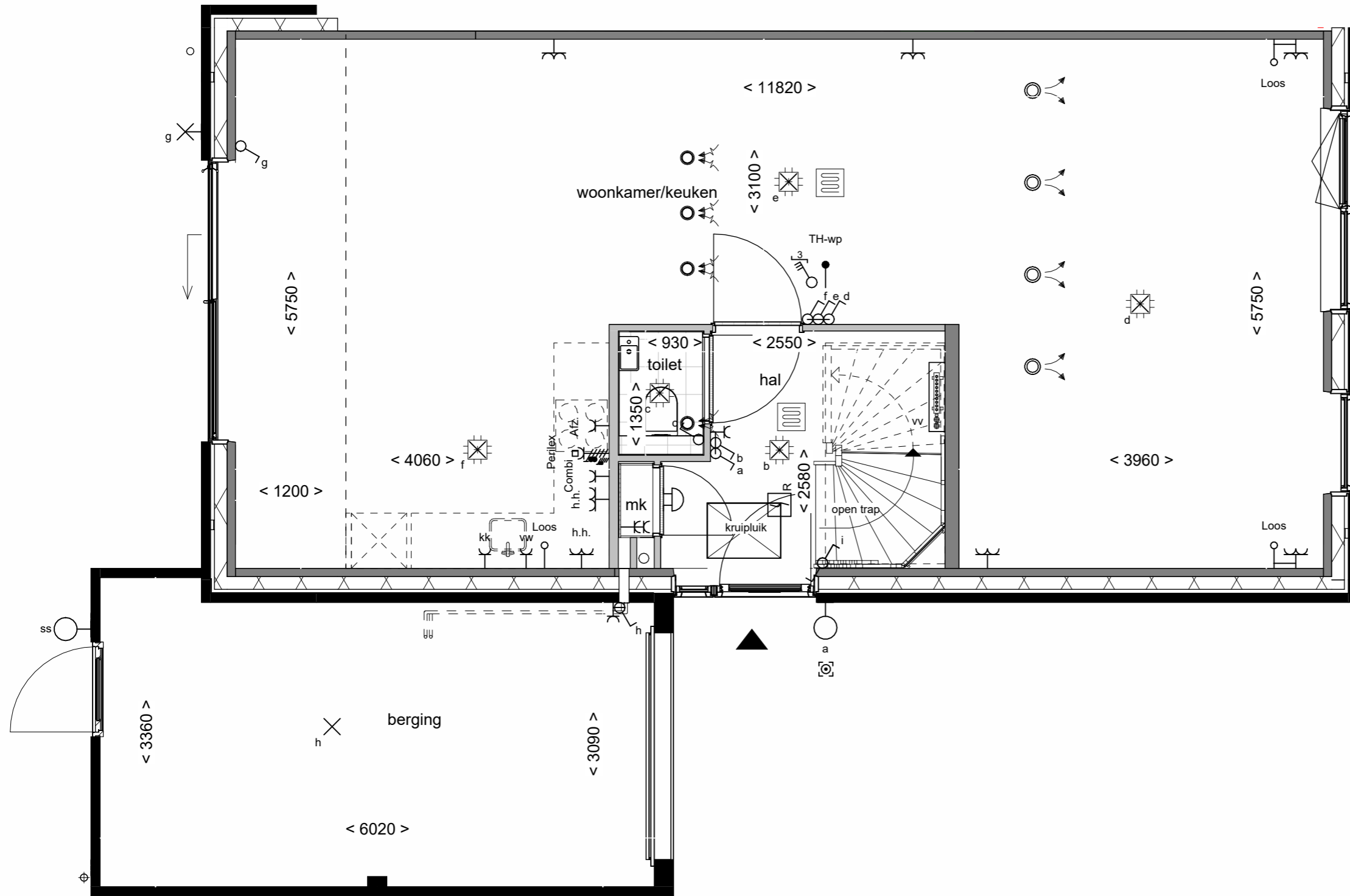

Achtergevel schaal 1:100

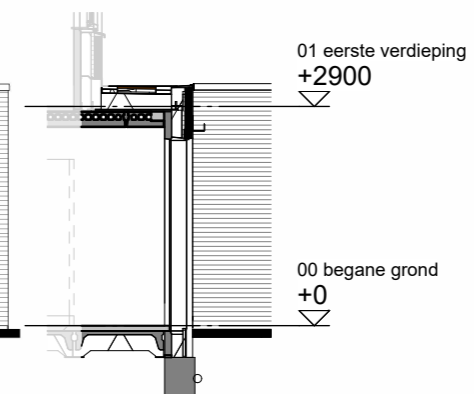

Doorsnede schaal 1:100



STEENBRUGGE  
DEVENTER



Uitbouw achtergevel  
120cm

Tekening:

Woningtype: E60

Bouwnummer: -

Optienummer: 1.A.X.18

Bladformaat: A3

Schaal: 1:50 / 1:100

Datum: 26-11-2024

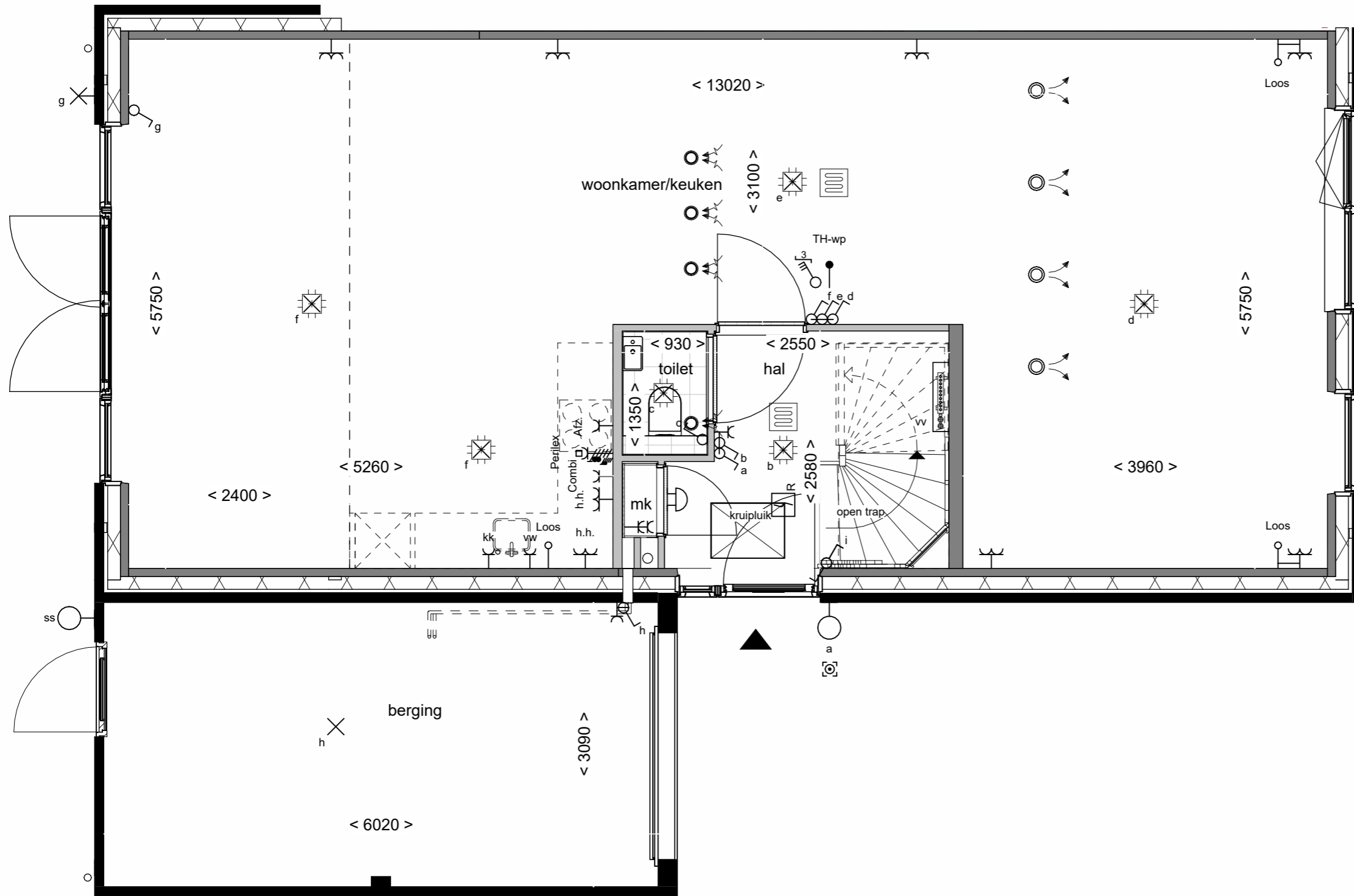

Achtergevel schaal 1:100

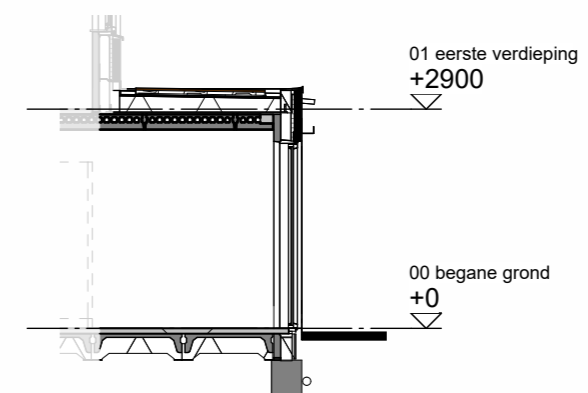

Doorsnede schaal 1:100



**STEENBRUGGE**  
DEVENTER



**Uitbouw achtergevel**  
240cm

Tekening: \_\_\_\_\_

Woningtype: E60

Bouwnummer: -

Optienummer: 1.A.X.38

Bladformaat: A3

Schaal: 1:50 / 1:100

Datum: 26-11-2024

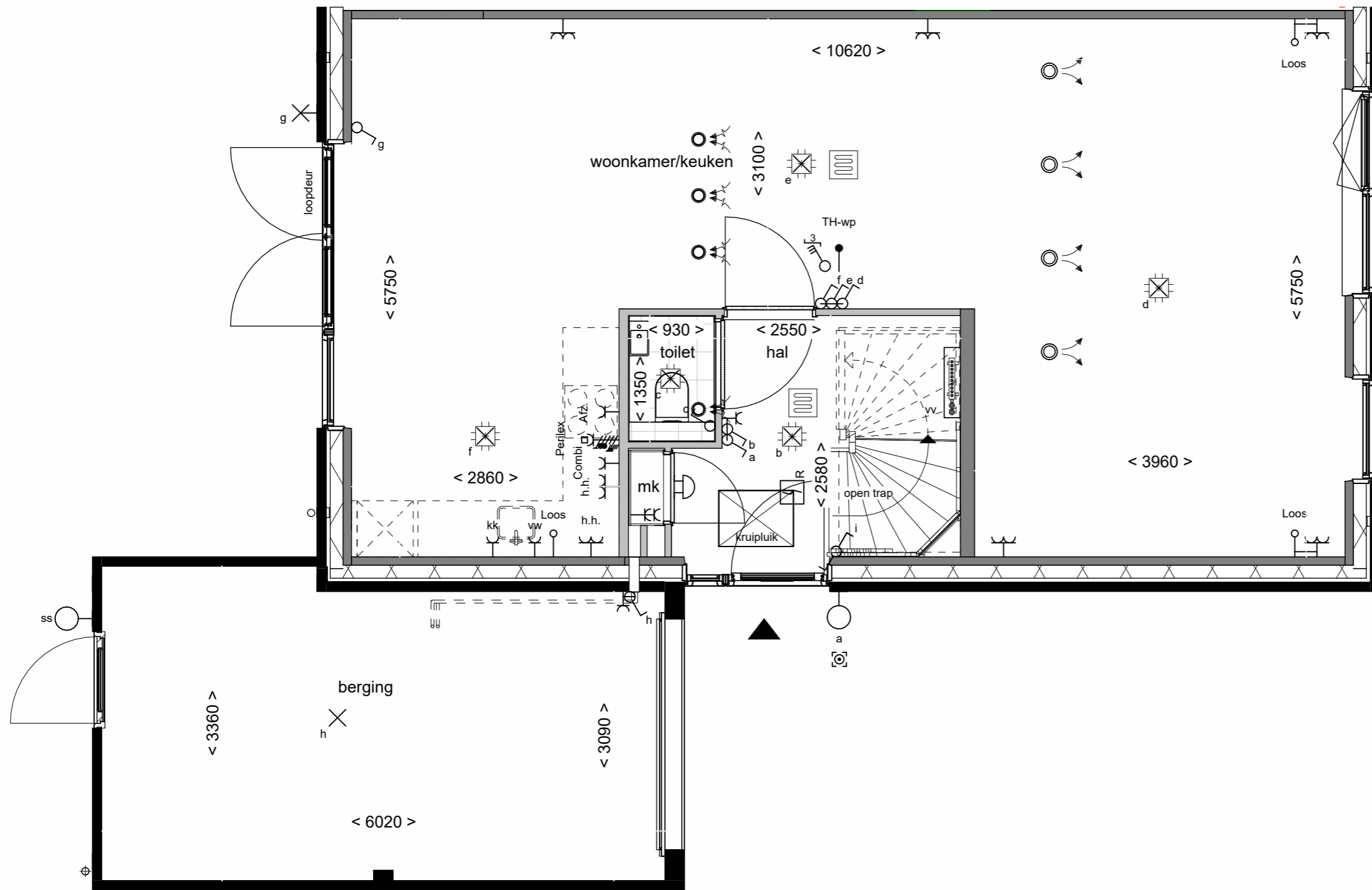

Achtergevel schaal 1:100



**STEENBRUGGE**  
DEVENTER



**VAN WIJNEN**  
Openslaande deuren  
met 1 zijlicht

Tekening: \_\_\_\_\_

Woningtype: E60 \_\_\_\_\_

Bouwnummer: - \_\_\_\_\_

Optienummer: 1.A.X.58 \_\_\_\_\_

Bladformaat: A3 \_\_\_\_\_

Schaal: 1:50 / 1:100 \_\_\_\_\_

Datum: 26-11-2024 \_\_\_\_\_

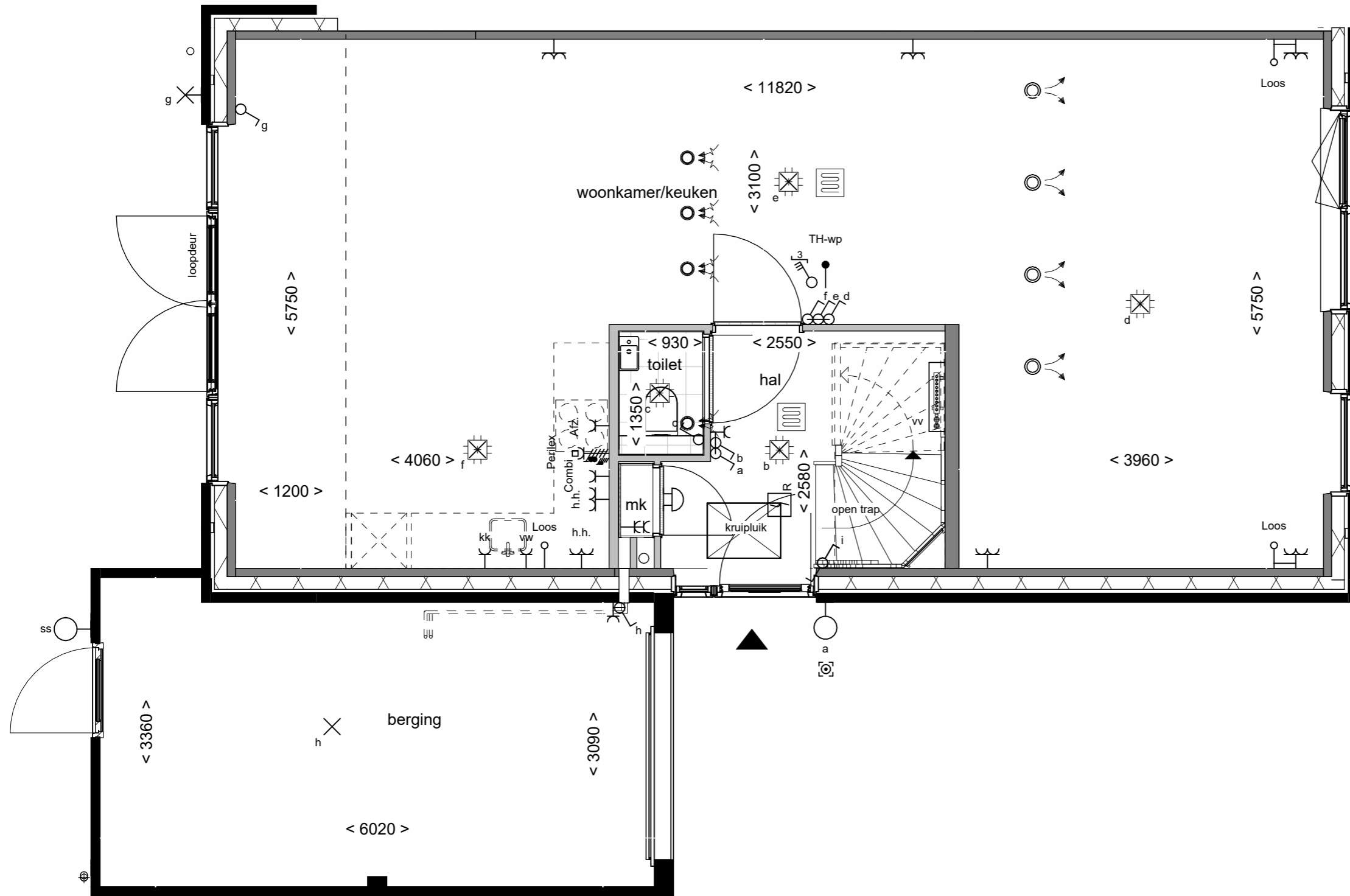

Achtergevel schaal 1:100



STEENBRUGGE  
DEVENTER



Tekening: Openslaande deuren  
2 zijlichten

Woningtype: E60

Bouwnummer: -

Optienummer: 1.A.X.62

Bladformaat: A3

Schaal: 1:50 / 1:100

Datum: 26-11-2024

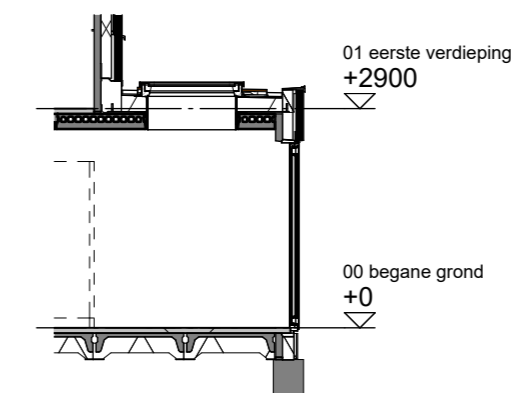
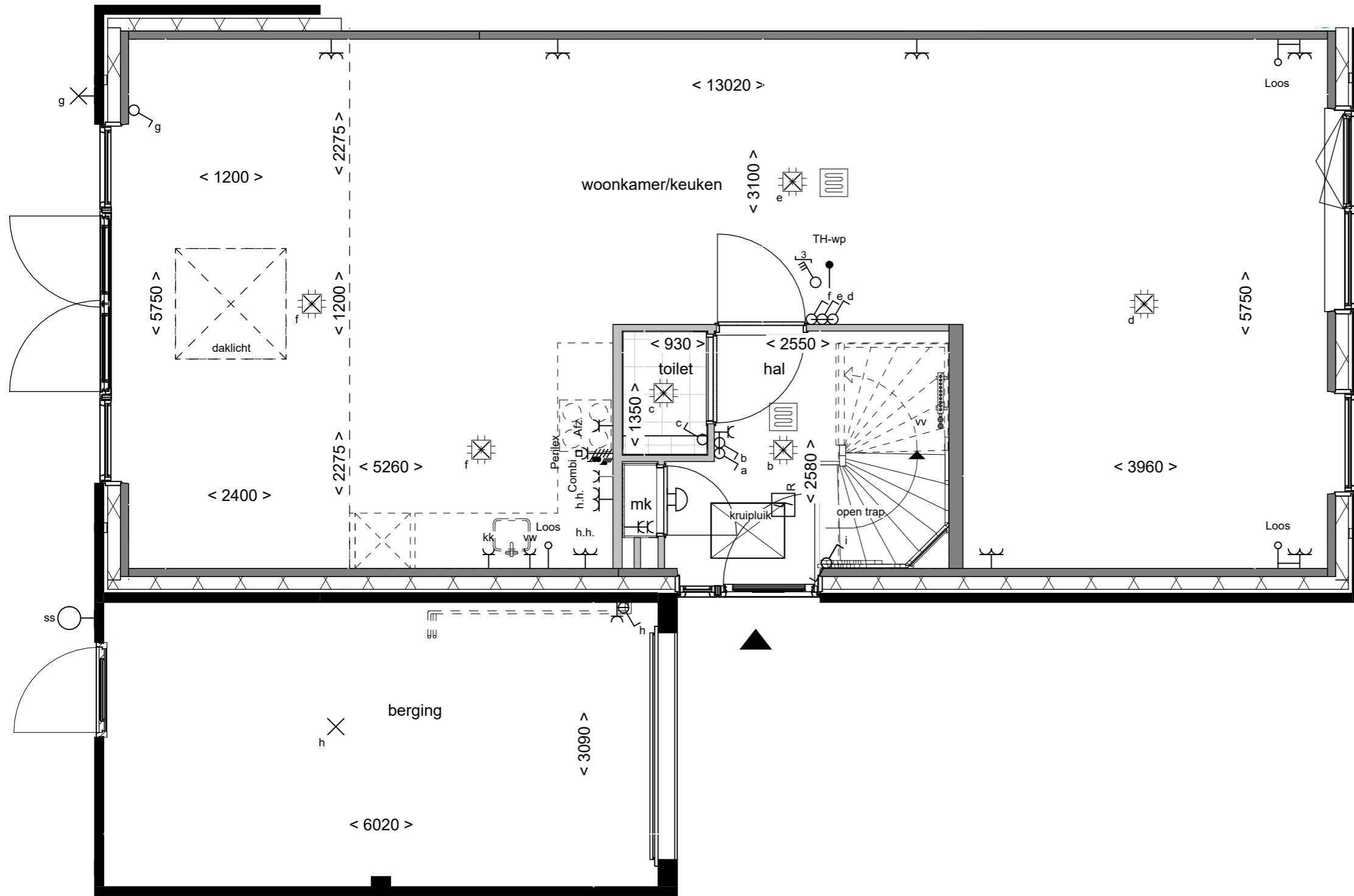

Doorsnede schaal 1:100



**STEENBRUGGE**  
DEVENTER



**Lichtkoepel in  
uitbouw 240cm**

Tekening:	Lichtkoepel in uitbouw 240cm
Woningtype:	E60
Bouwnummer:	-
Optienummer:	1.B.X.10
Bladformaat:	A3
Schaal:	1:50 / 1:100
Datum:	26-11-2024

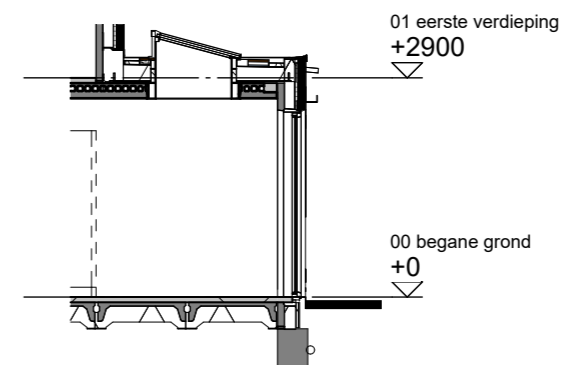
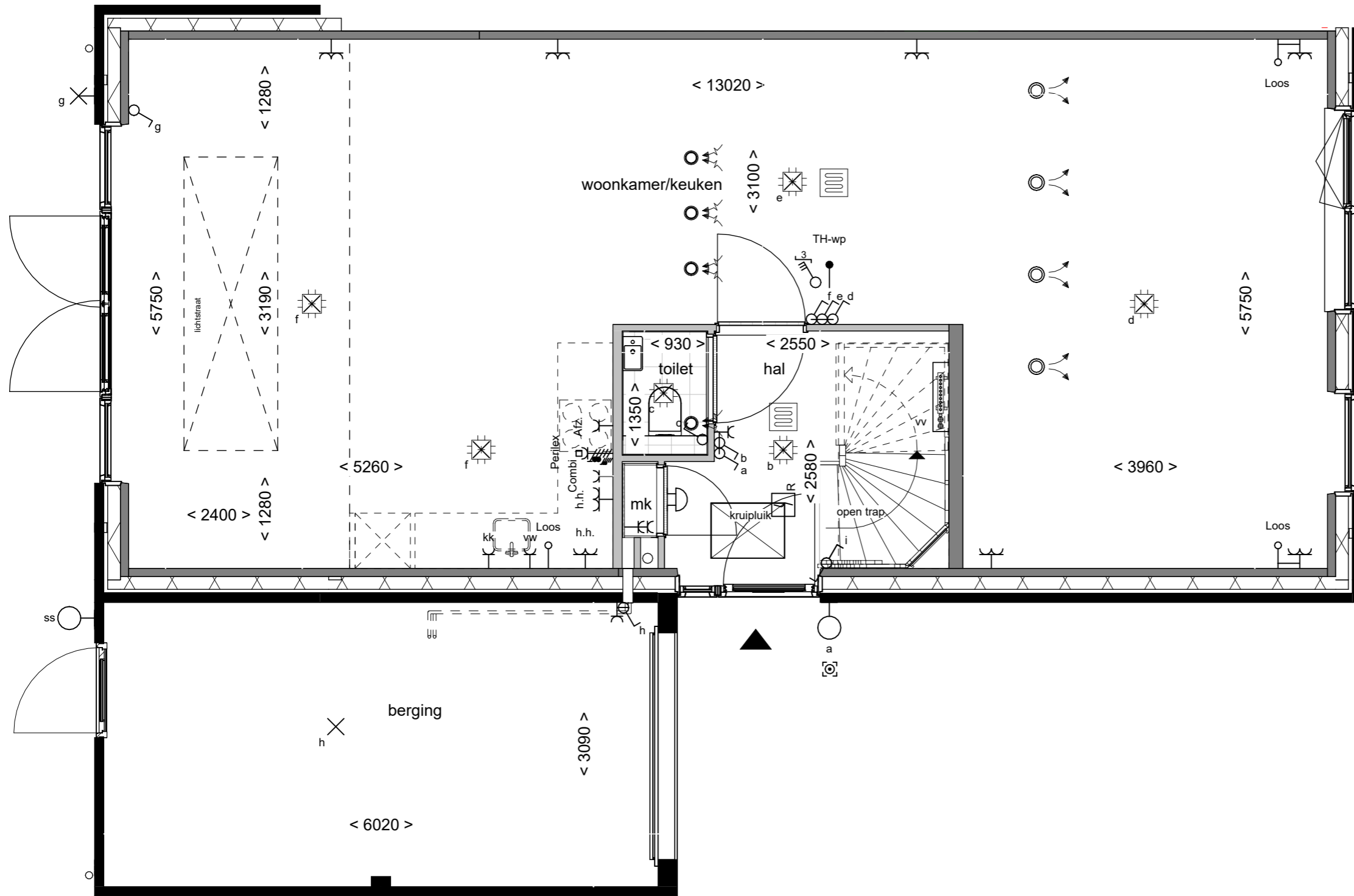

Doorsnede schaal 1:100



STEENBRUGGE  
DEVENTER



Tekening: Lichtstraat in uitbouw  
240cm  
Woningtype: E60  
Bouwnummer: -  
Optienummer: 1.B.X.14  
Bladformaat: A3  
Schaal: 1:50 / 1:100  
Datum: 26-11-2024

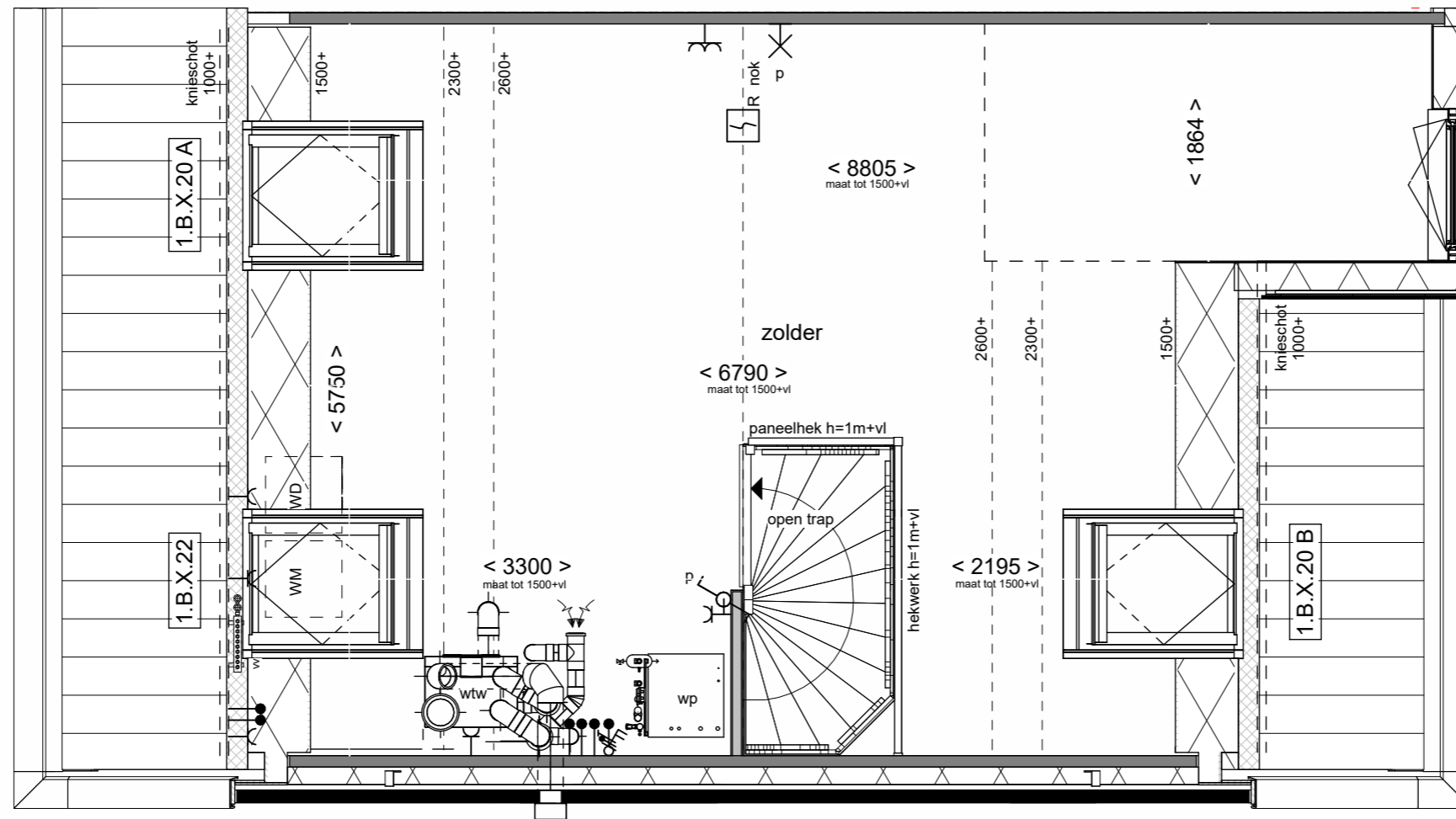

Vorgevel schaal 1:100

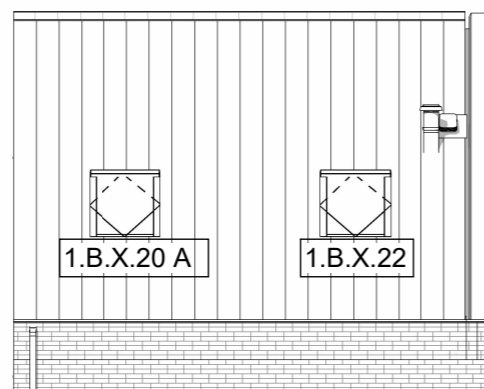

Achtergevel schaal 1:100

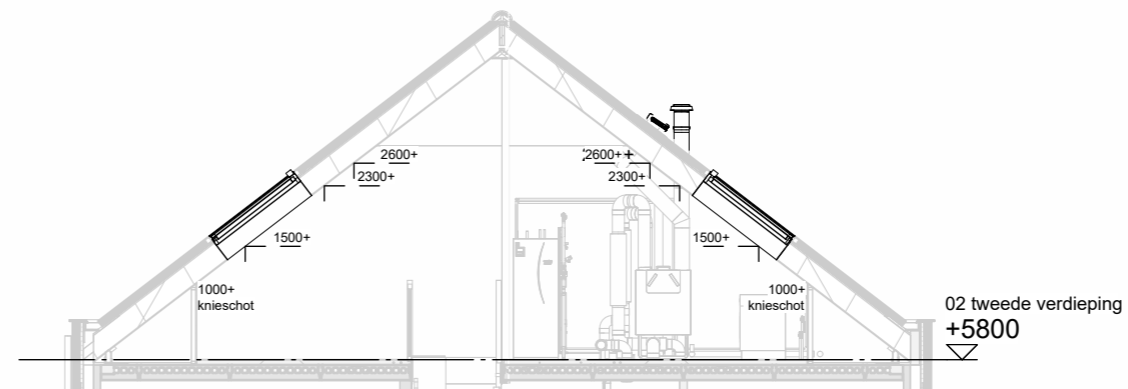

Doorsnede schaal 1:100



STEENBRUGGE  
DEVENTER



VAN WIJNEN

Tekening: Dakramen voor- en achtergevel

Woningtype: E60

Bouwnummer: -

Optienummer: 1.B.X.20 / 1.B.X.22

Bladformaat: A3

Schaal: 1:50 / 1:100

Datum: 26-11-2024



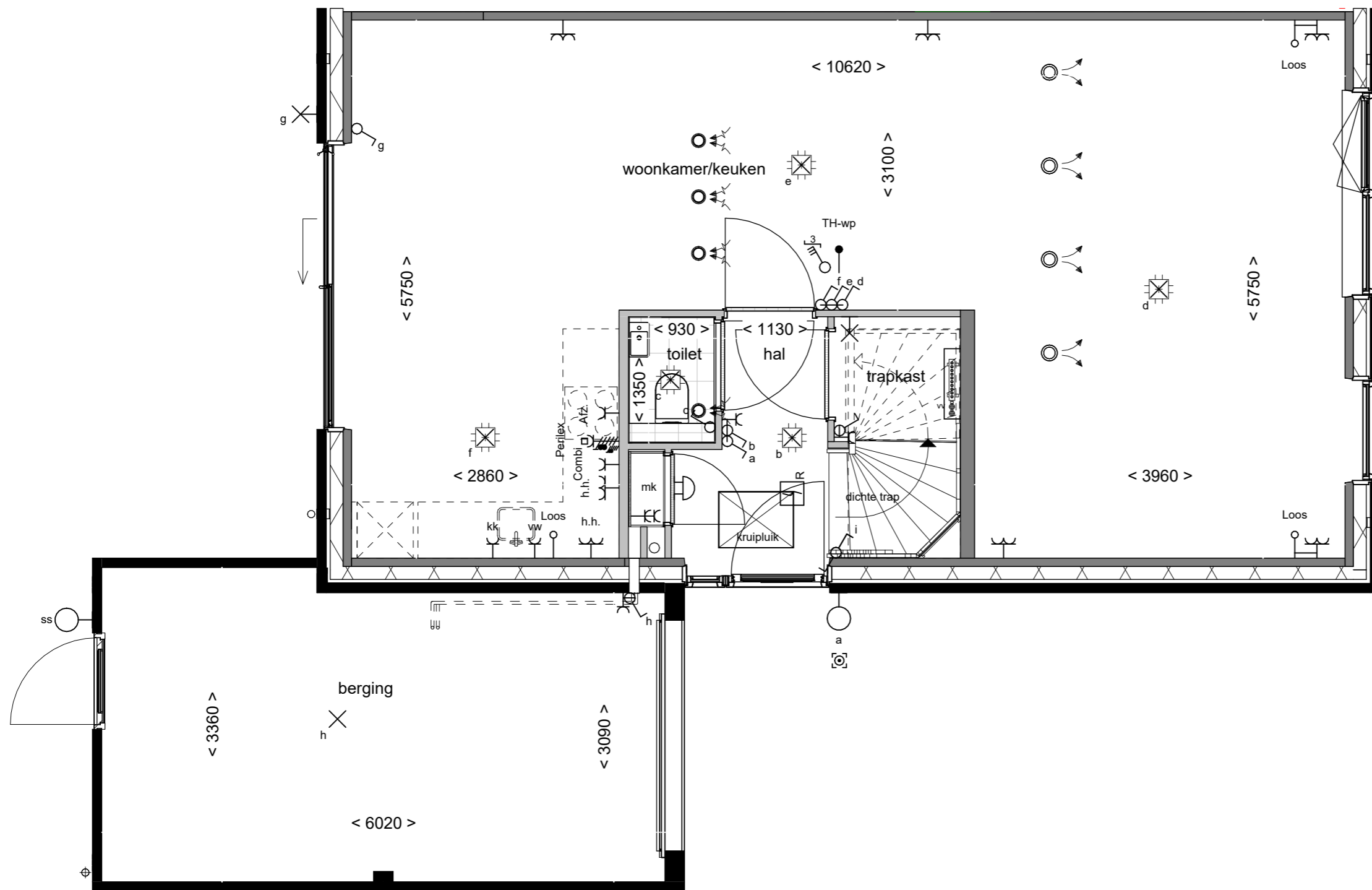

STEENBRUGGE  
DEVENTER



### Trapkast

Tekening:	_____
Woningtype:	E60
Bouwnummer:	-
Optienummer:	1.C.E.10
Bladformaat:	A3
Schaal:	1:50
Datum:	26-11-2024

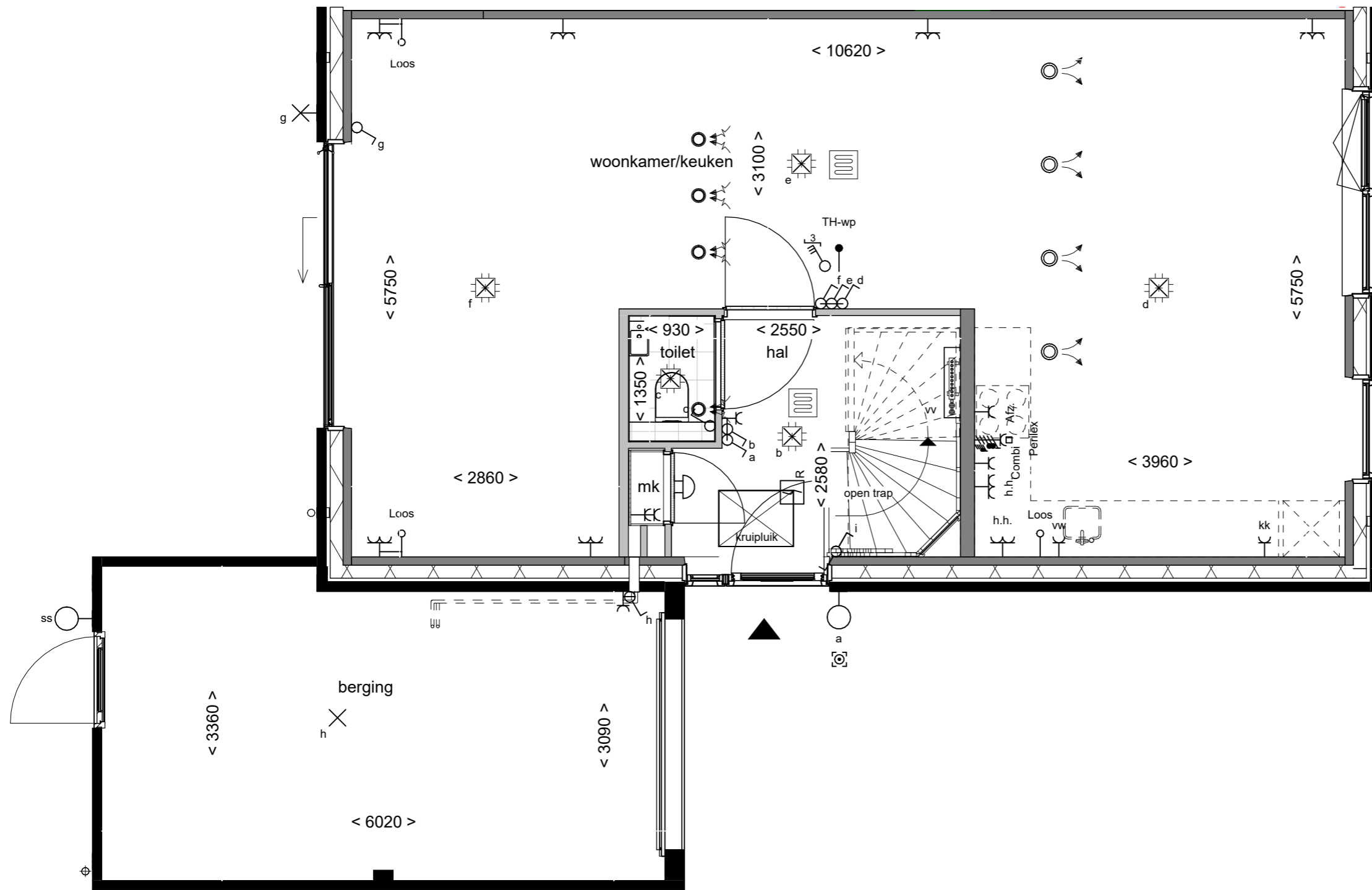

STEENBRUGGE  
DEVENTER



Tuingericht wonen

Tekening: \_\_\_\_\_

Woningtype: E60

Bouwnummer: -

Optienummer: 1.C.E.12

Bladformaat: A3

Schaal: 1:50

Datum: 26-11-2024

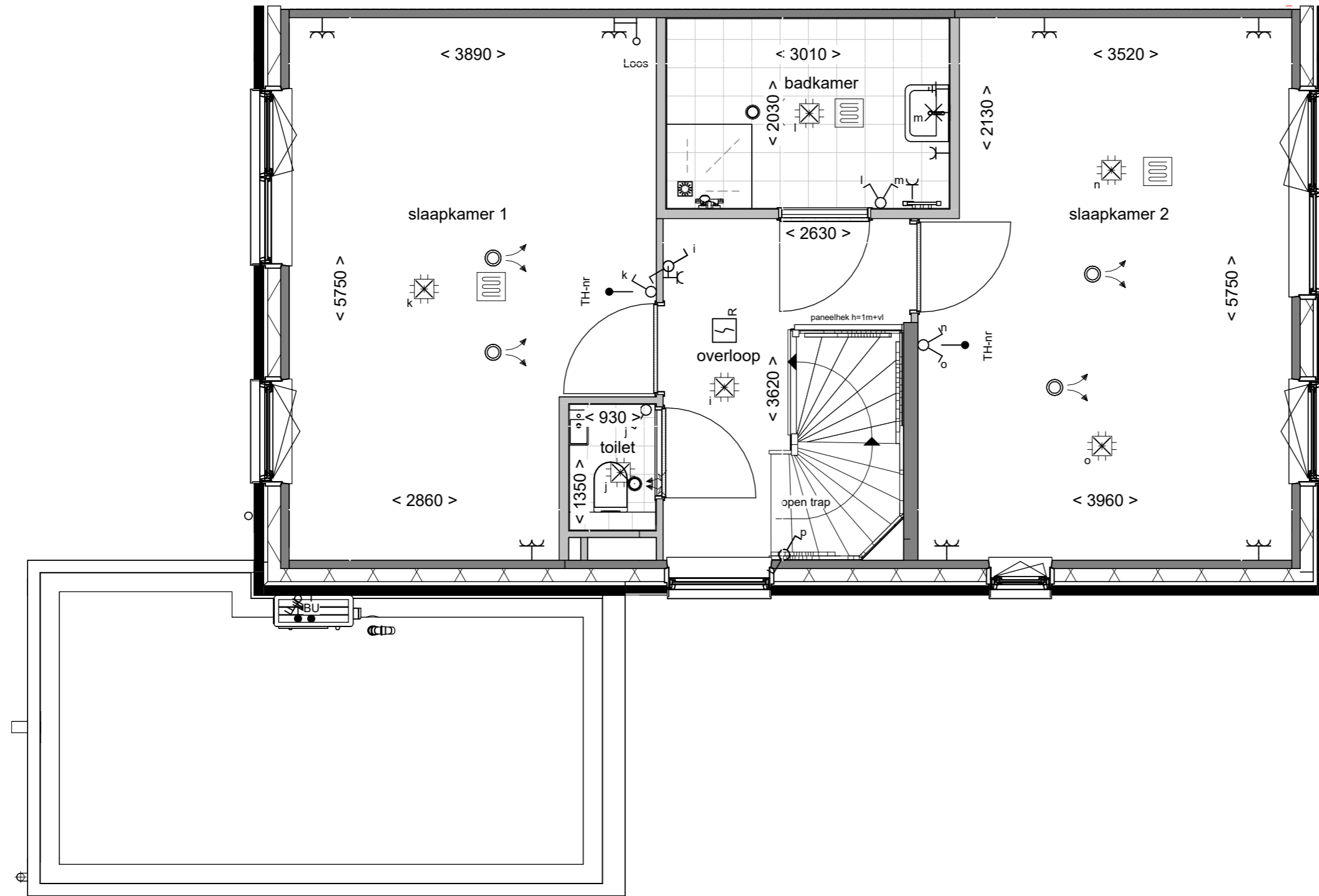

**STEENBRUGGE**  
DEVENTER



**Samenvoegen  
slaapkamers voor**

Tekening:

Woningtype: E60

Bouwnummer: -

Optienummer: 1.C.E.30

Bladformaat: A3

Schaal: 1:50

Datum: 26-11-2024

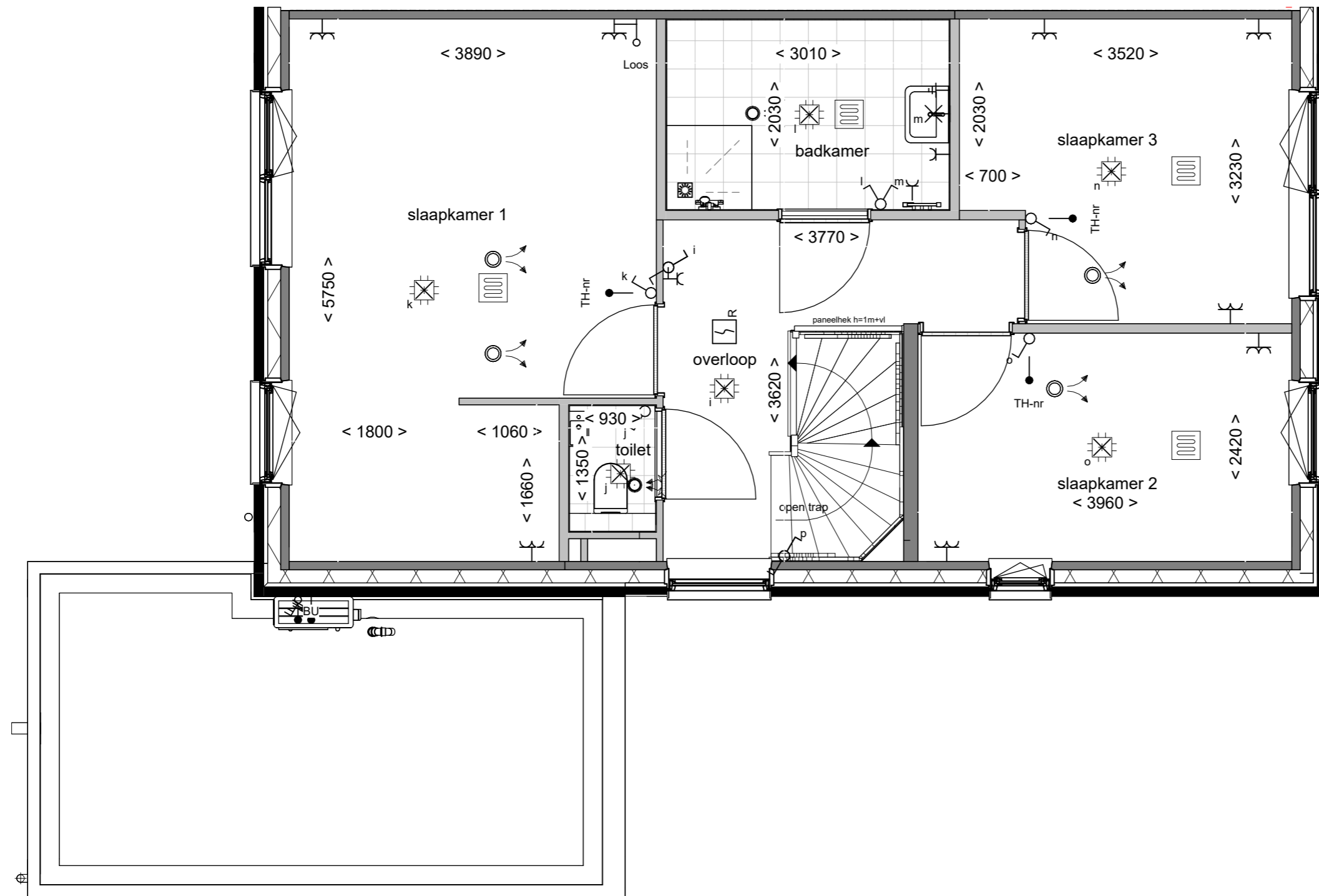

**STEENBRUGGE**  
DEVENTER



**VAN WIJNEN**

Tekening: Inloopkast in slaapkamer achter

Woningtype: E60

Bouwnummer: -

Optienummer: 1.C.E.32

Bladformaat: A3

Schaal: 1:50

Datum: 26-11-2024

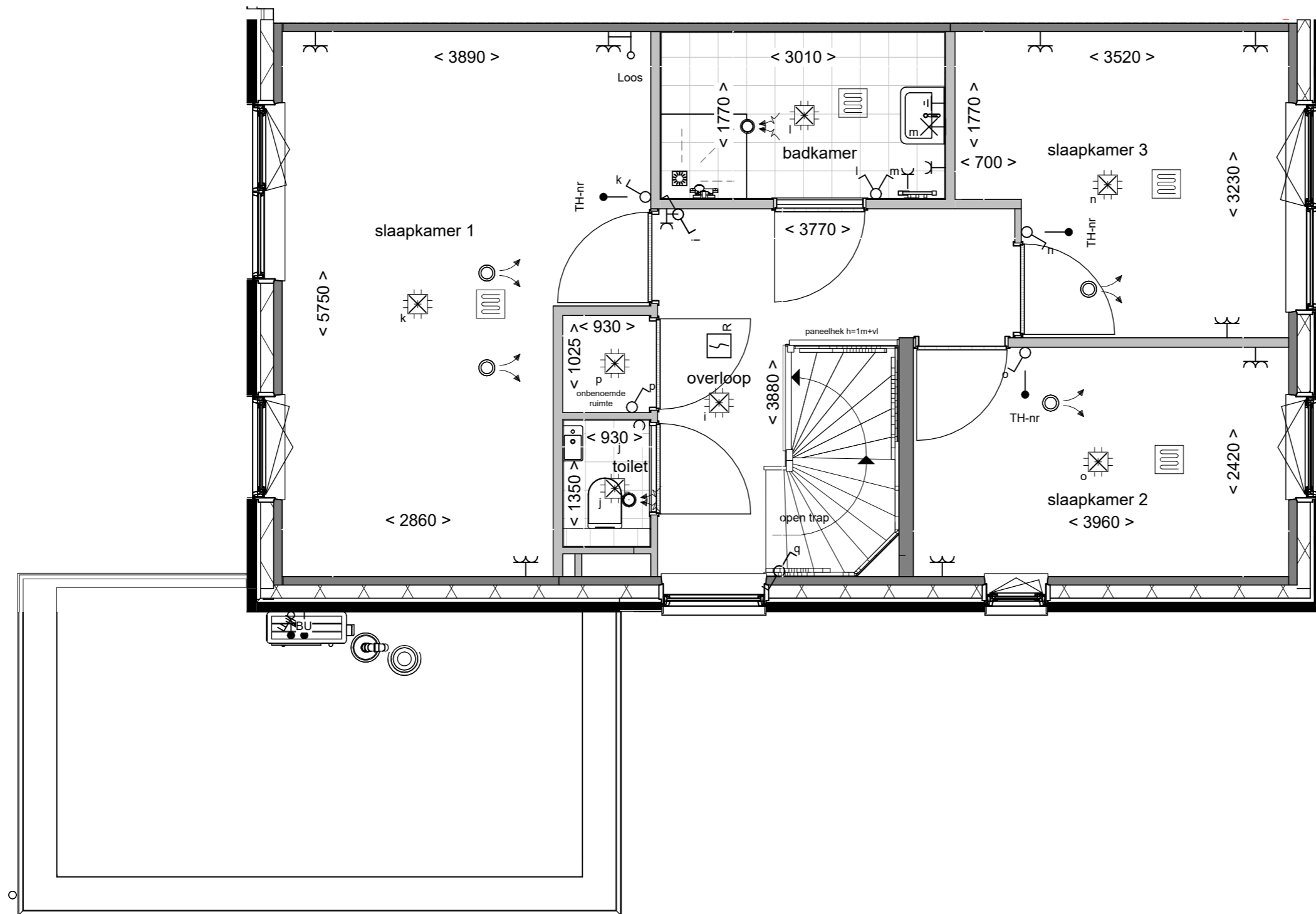

**STEENBRUGGE**  
DEVENTER



Vaste kast en  
compacte badkamer

Tekening:

Woningtype: E60

Bouwnummer: -

Optienummer: 1.C.E.34

Bladformaat: A3

Schaal: 1:50

Datum: 26-11-2024

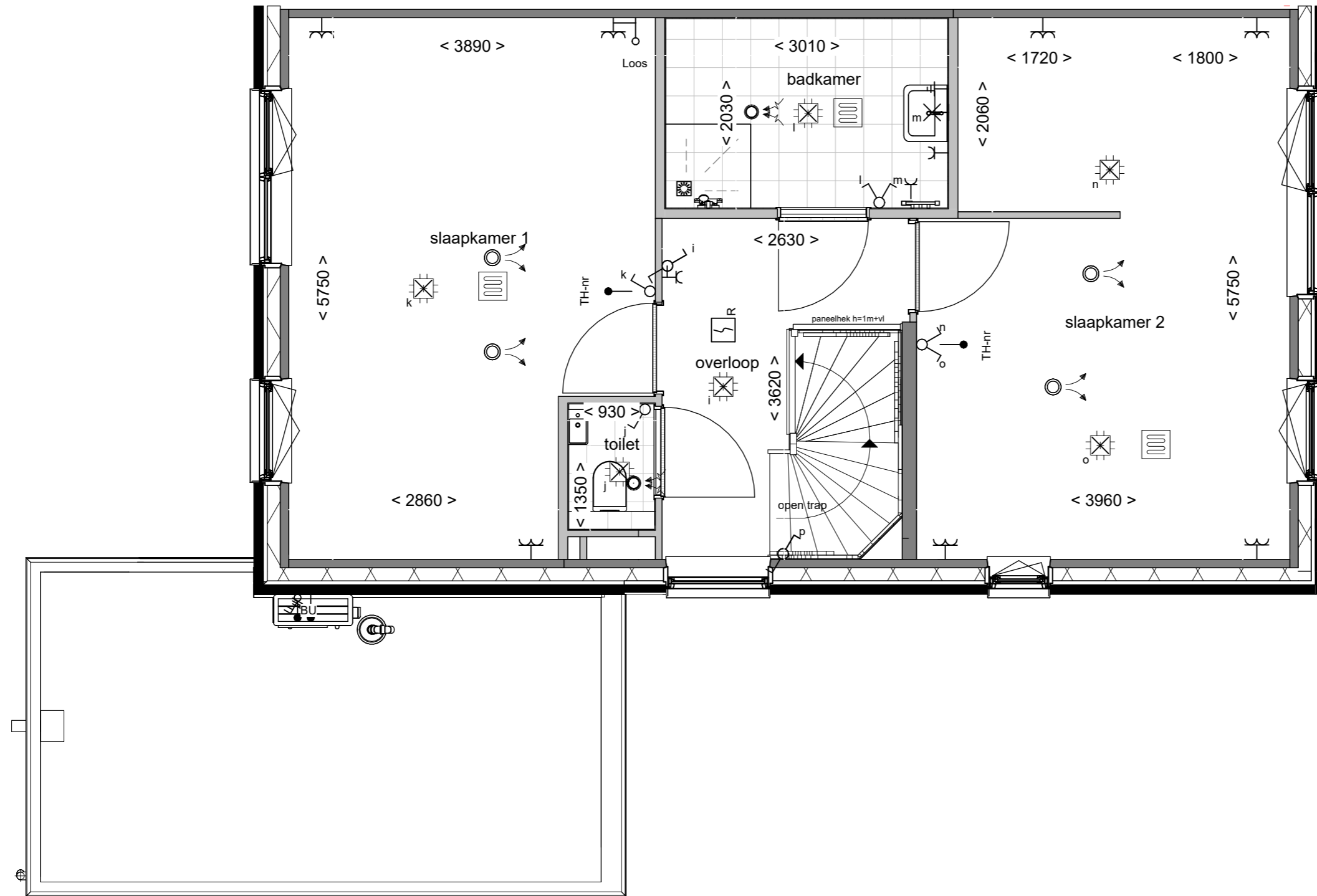

**STEENBRUGGE**  
DEVENTER



**VAN WIJNEN**  
Samenvoegen slpk  
voor met inloopkast

Tekening:

Woningtype: E60

Bouwnummer: -

Optienummer: 1.C.E.36

Bladformaat: A3

Schaal: 1:50

Datum: 26-11-2024

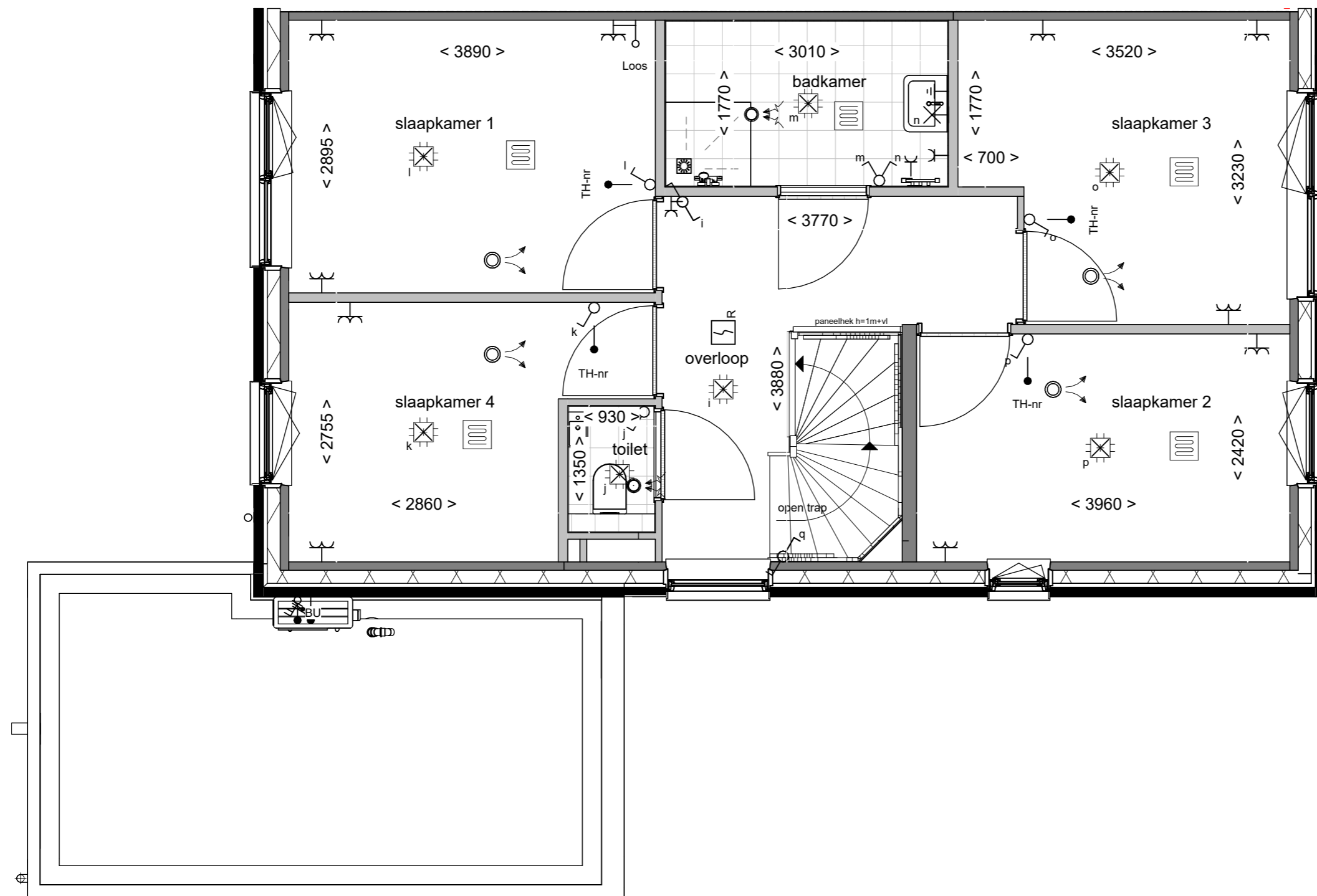

**STEENBRUGGE**  
DEVENTER



**VAN WIJNEN**  
Compacte badk. met  
4 slaapkamers

Tekening: Compacte badk. met  
4 slaapkamers

Woningtype: E60

Bouwnummer: -

Optienummer: 1.C.E.38

Bladformaat: A3

Schaal: 1:50

Datum: 26-11-2024

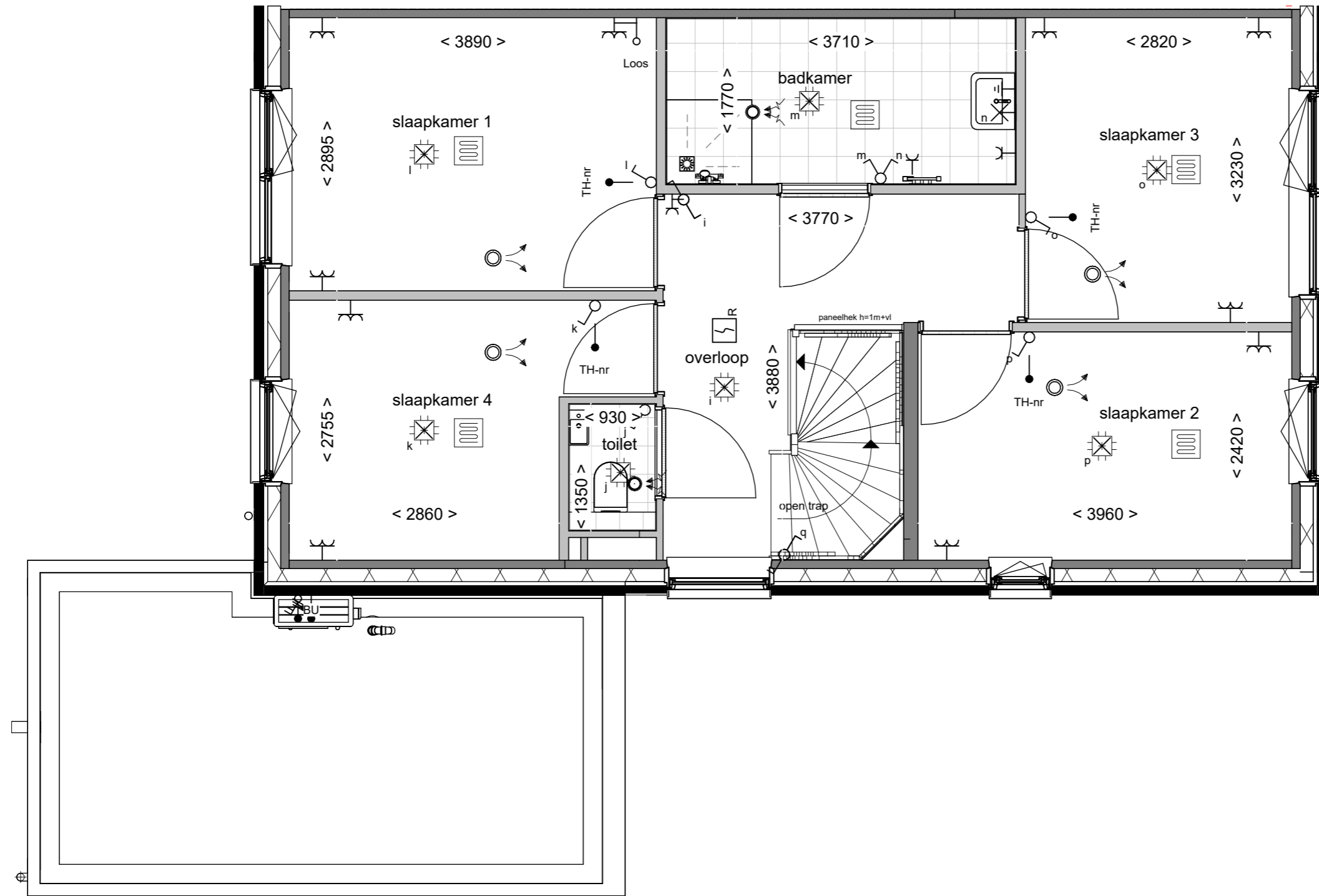

**STEENBRUGGE**  
DEVENTER



Tekening: Verl. compacte badk. met 4 slpk  
 Woningtype: E60  
 Bouwnummer: -  
 Optienummer: 1.C.E.40  
 Bladformaat: A3  
 Schaal: 1:50  
 Datum: 26-11-2024



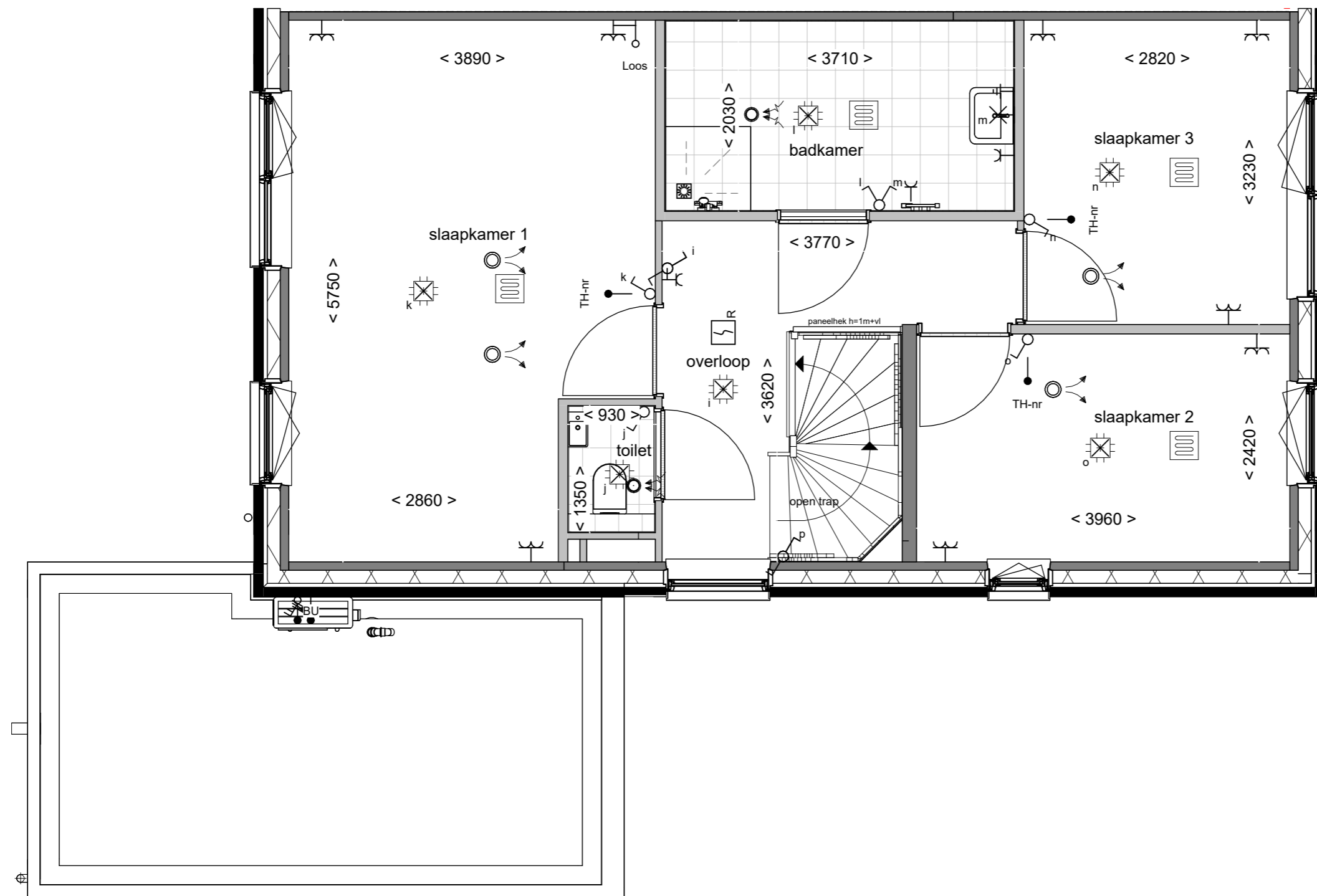

**STEENBRUGGE**  
DEVENTER



**Badkamer vergroten**

Tekening: \_\_\_\_\_

Woningtype: E60

Bouwnummer: -

Optienummer: 1.C.E.42

Bladformaat: A3

Schaal: 1:50

Datum: 26-11-2024



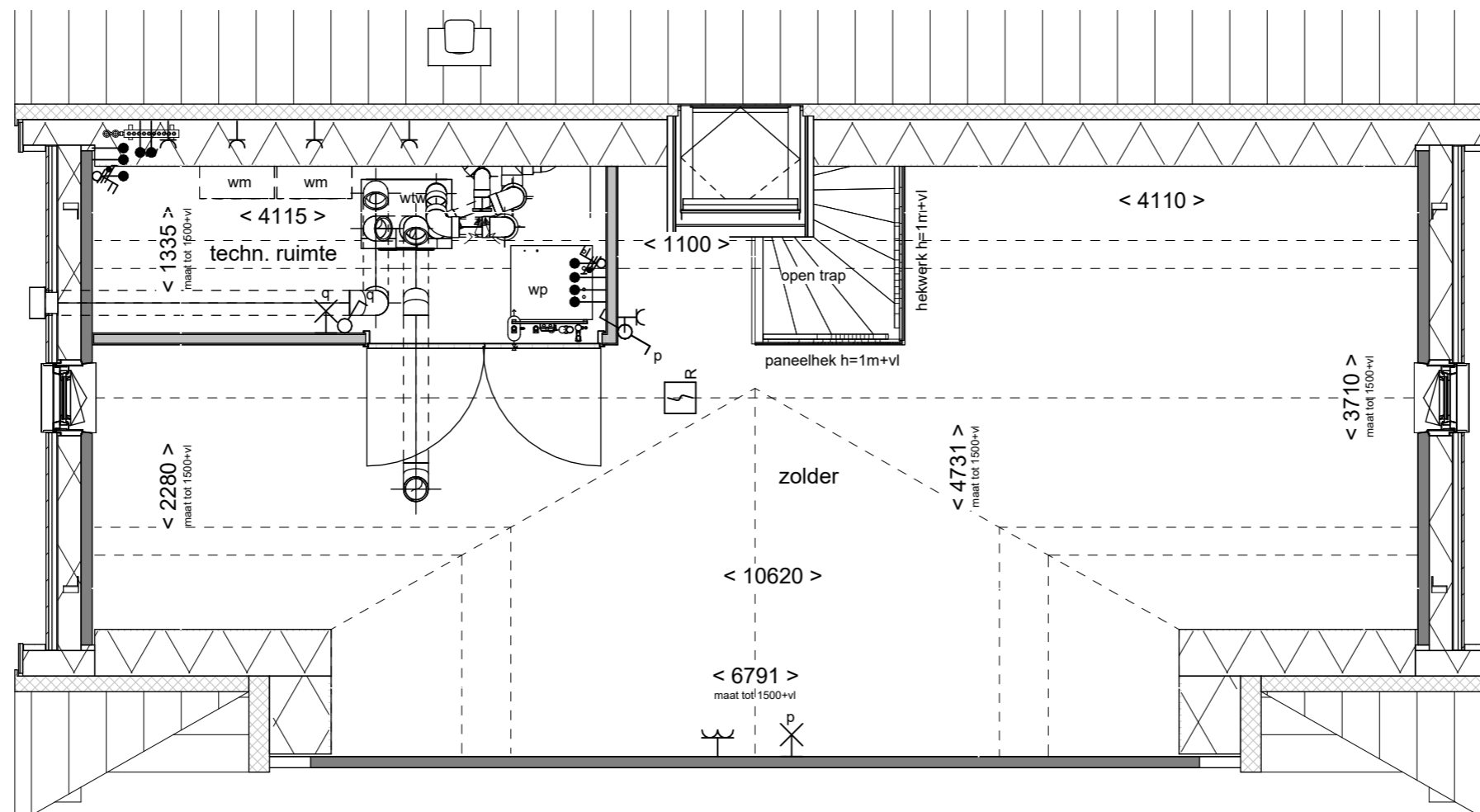

**STEENBRUGGE**  
DEVENTER



Tekening: **Indeling met  
techniekkast**

Woningtype: **E60-D**

Bouwnummer: **-**

Optienummer: **1.C.E.70**

Bladformaat: **A3**

Schaal: **1:50**

Datum: **26-11-2024**

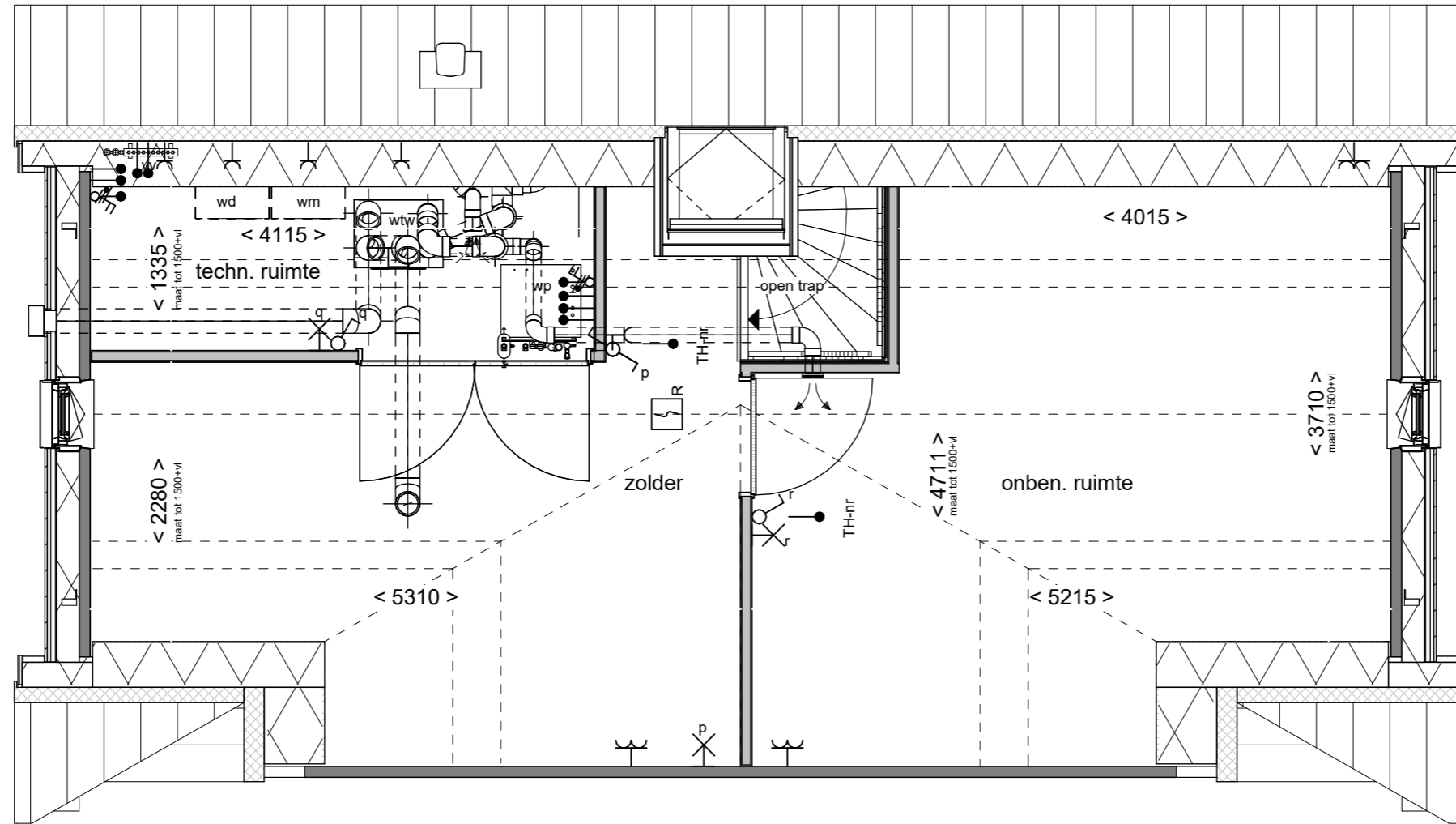

**STEENBRUGGE**  
DEVENTER



Tekening: **Indeling met 1  
onbenoemde r.**

Woningtype: **E60-D**

Bouwnummer: **-**

Optienummer: **1.C.E.72**

Bladformaat: **A3**

Schaal: **1:100**

Datum: **26-11-2024**

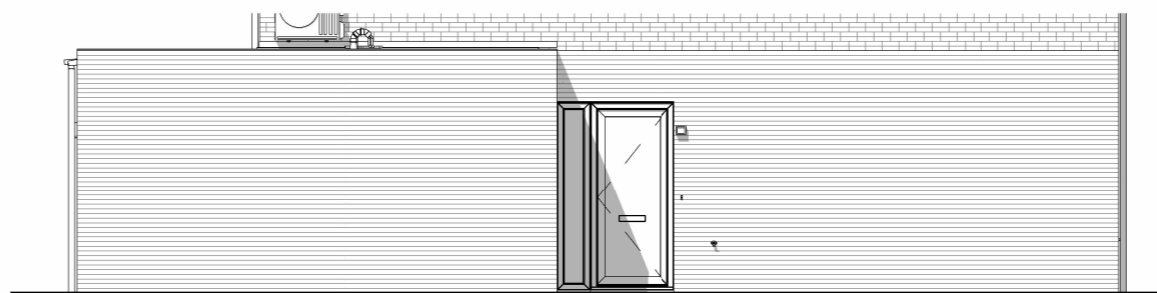
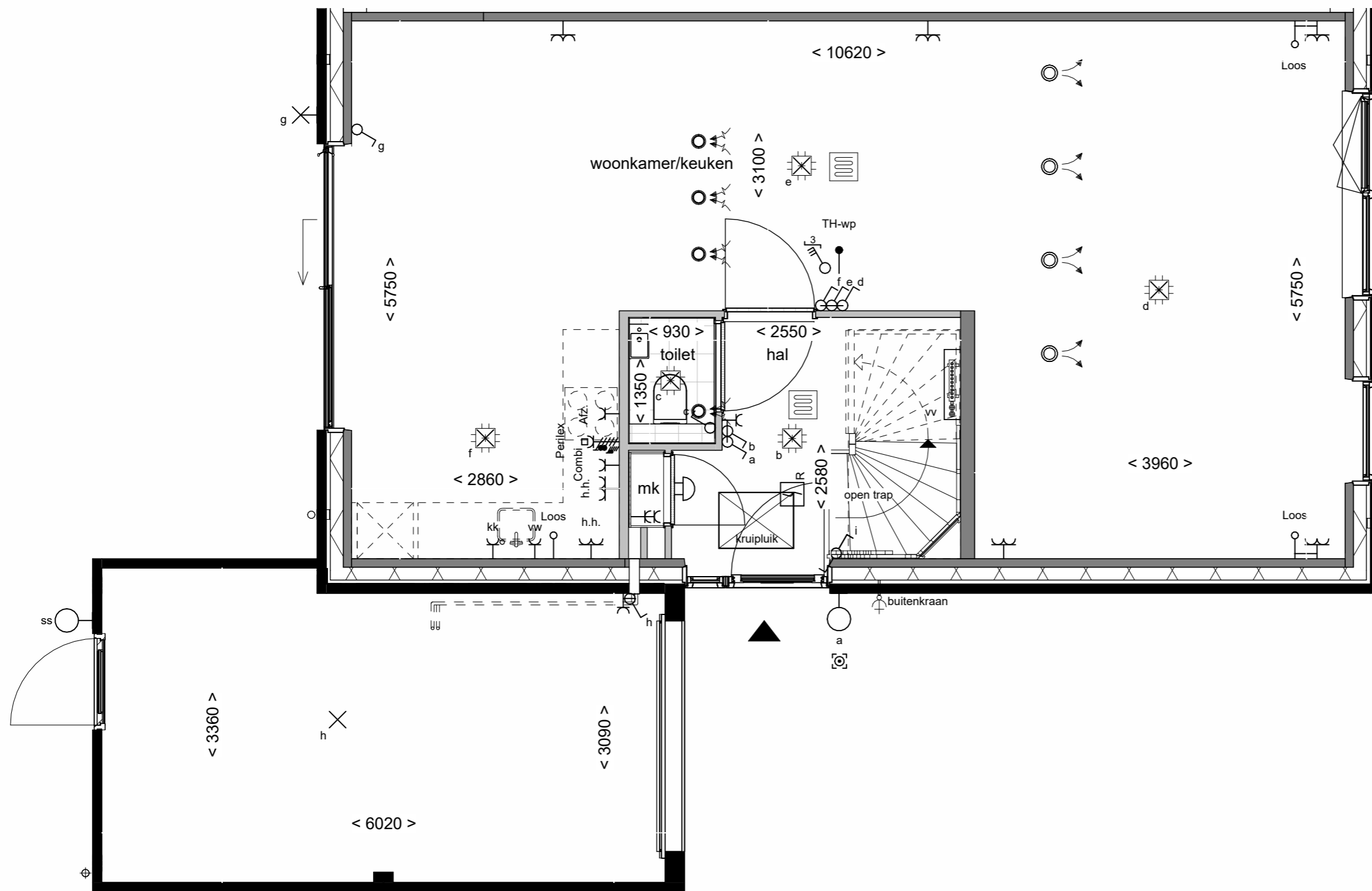

Linkerzijgevel schaal 1:100



STEENBRUGGE  
DEVENTER



vorstvrije  
buitenkraan links

Tekening: vorstvrije buitenkraan links

Woningtype: E60

Bouwnummer: -

Optienummer: 2.K.0.40

Bladformaat: A3

Schaal: 1:50 / 1:100

Datum: 26-11-2024

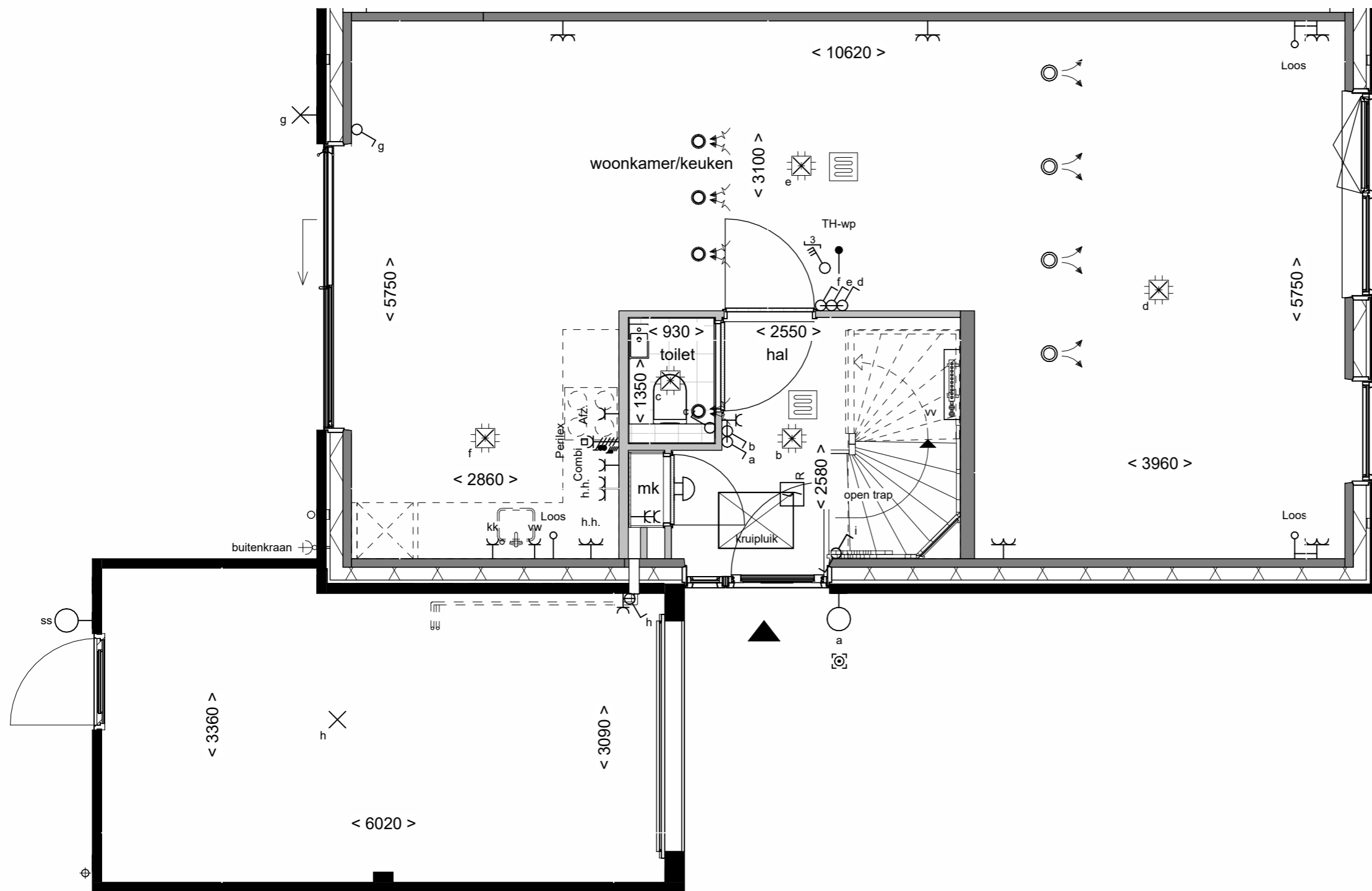

Achtergevel schaal 1:100



**STEENBRUGGE**  
DEVENTER



**VAN WIJNEN**  
vorstvrij buitenkraan  
achter

Tekening: vorstvrij buitenkraan achter

Woningtype: E60

Bouwnummer: -

Optienummer: 2.K.0.44

Bladformaat: A3

Schaal: 1:50 / 1:100

Datum: 26-11-2024