

Doorsnede schaal 1:100

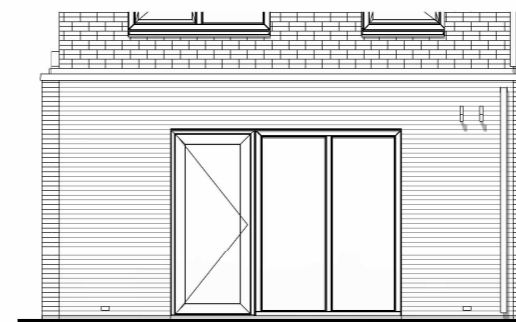

Achtergevel schaal 1:100



STEENBRUGGE
DEVENTER



Uitbouw
achtergevel 120cm

Tekening: **C60**

Bouwnummer: -

Optienummer: **1.A.X.18**

Bladformaat: **A3**

Schaal: **1:50 / 1:100**

Datum: **26-11-2024**

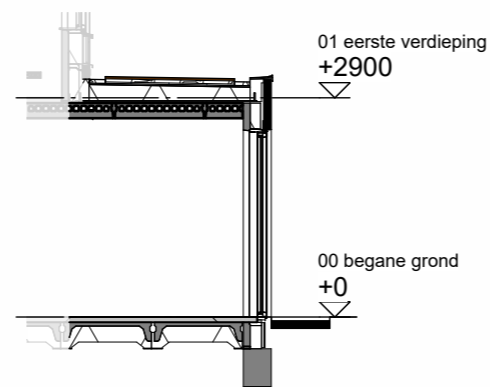
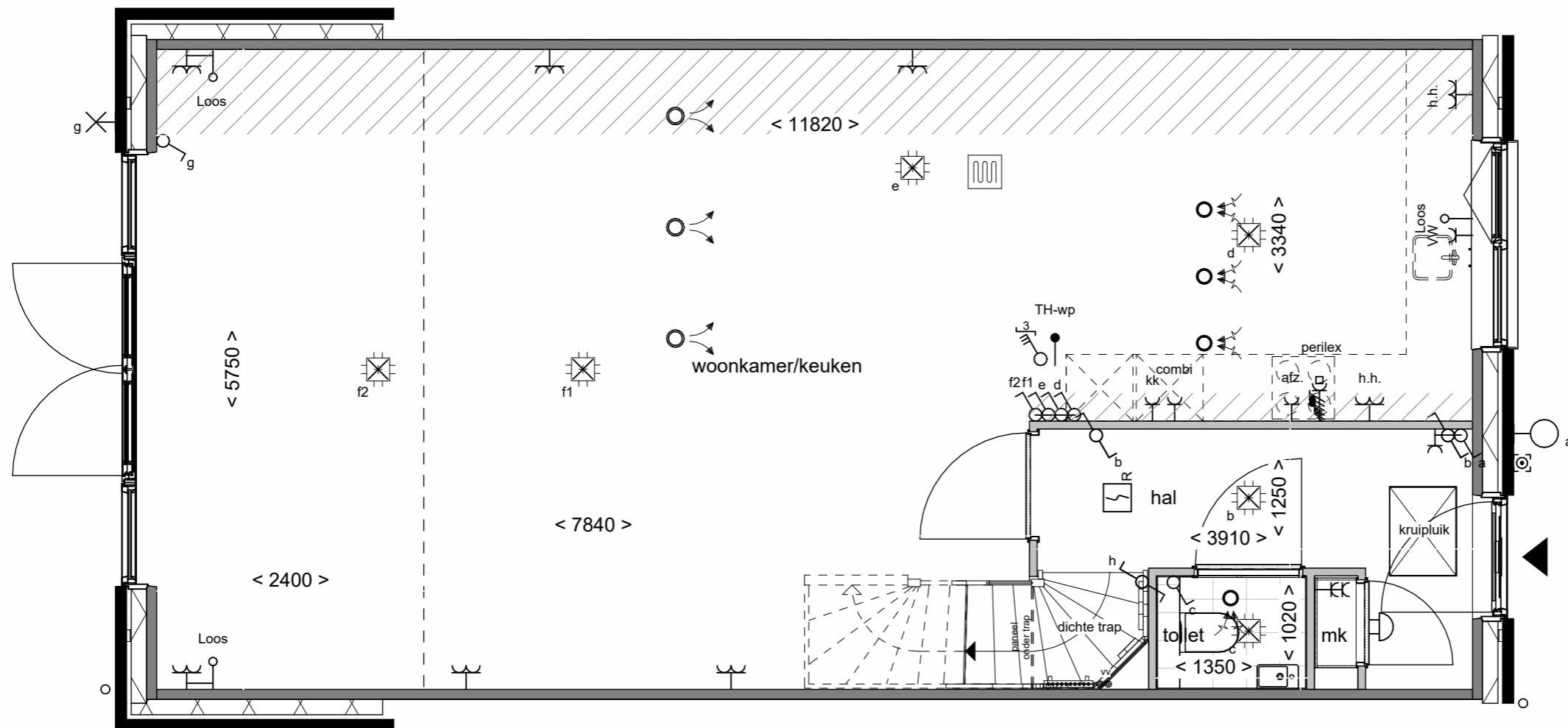

Doorsnede schaal 1:100

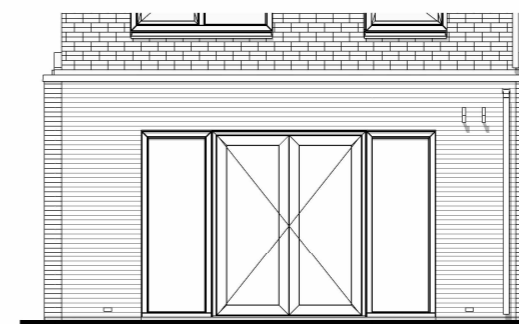

Achtergevel schaal 1:100



STEENBRUGGE
DEVENTER



Uitbouw
achtergevel 240cm

Tekening: Woningtype: C60

Bouwnummer: -

Optienummer: 1.A.X.38

Bladformaat: A3

Schaal: 1:50 / 1:100

Datum: 26-11-2024

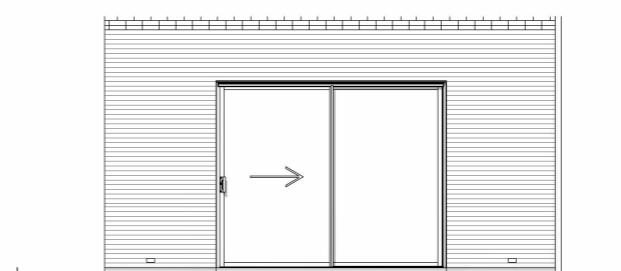
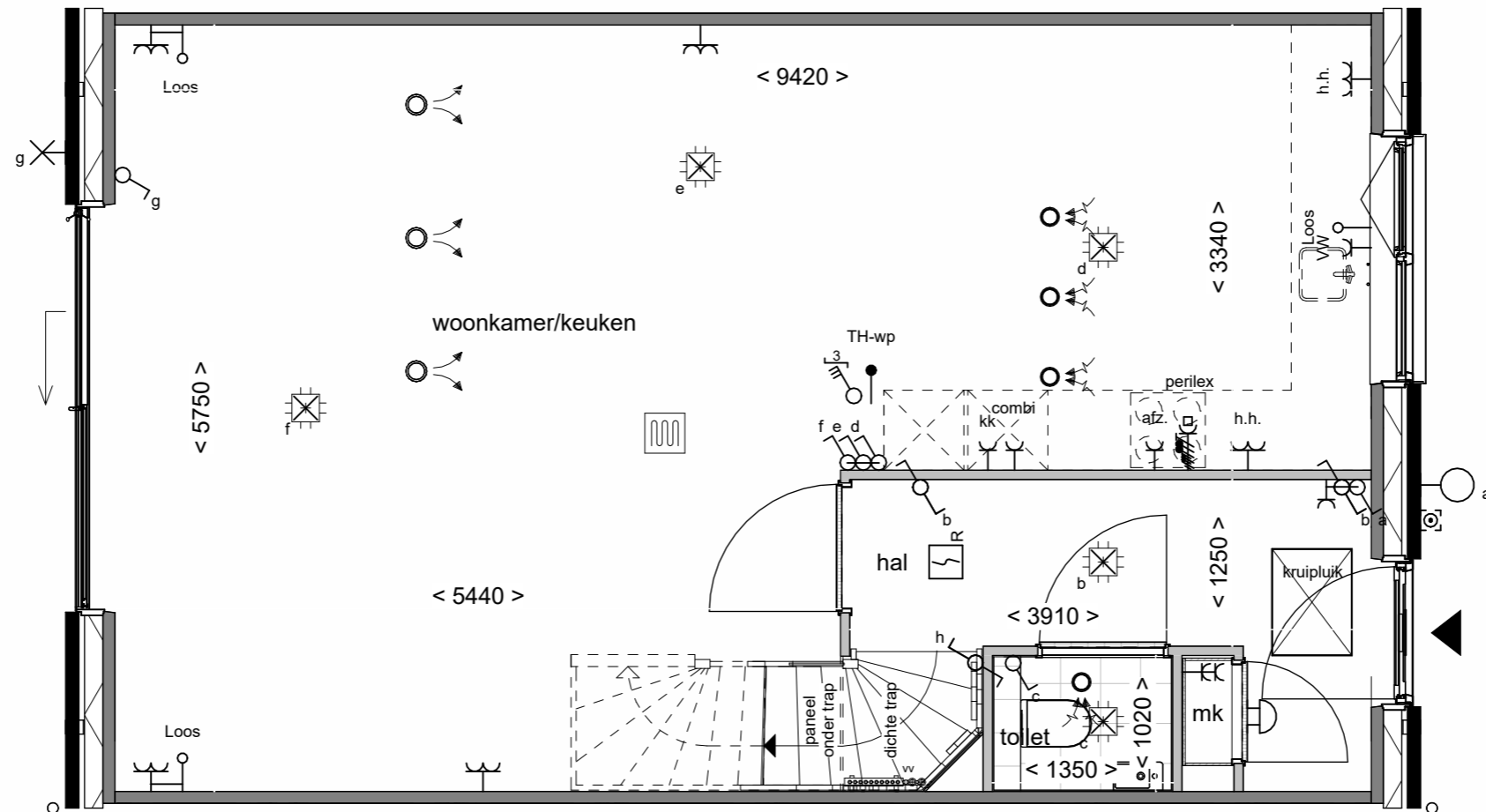

Achtergevel schaal 1:100



STEENBRUGGE
DEVENTER



**Aluminium
schuifpui**

Tekening: Aluminium schuifpui

Woningtype: C60

Bouwnummer: -

Optienummer: 1.A.X.52

Bladformaat: A3

Schaal: 1:50 / 1:100

Datum: 26-11-2024

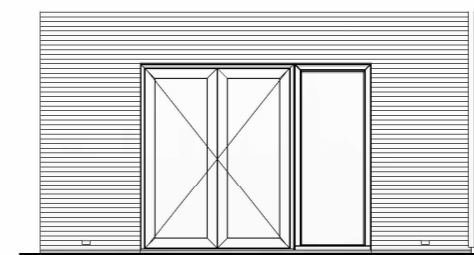
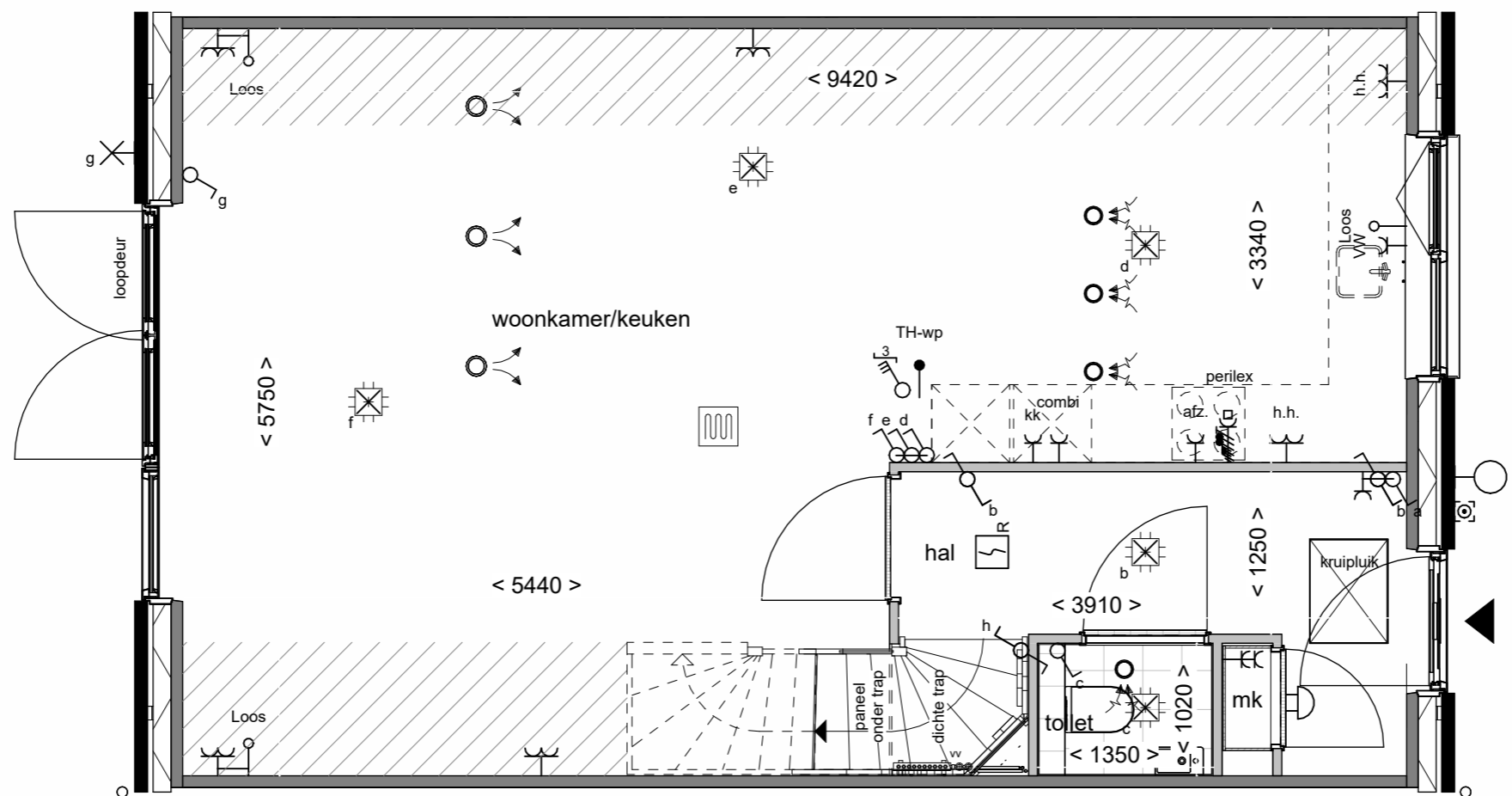

Achtergevel schaal 1:100



STEENBRUGGE
DEVENTER



Openslaande
deuren 1 zijlicht

Tekening:

Woningtype: C60

Bouwnummer: -

Optienummer: 1.A.X.58

Bladformaat: A3

Schaal: 1:50 / 1:100

Datum: 26-11-2024

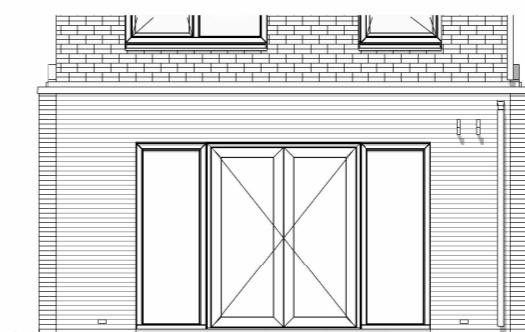
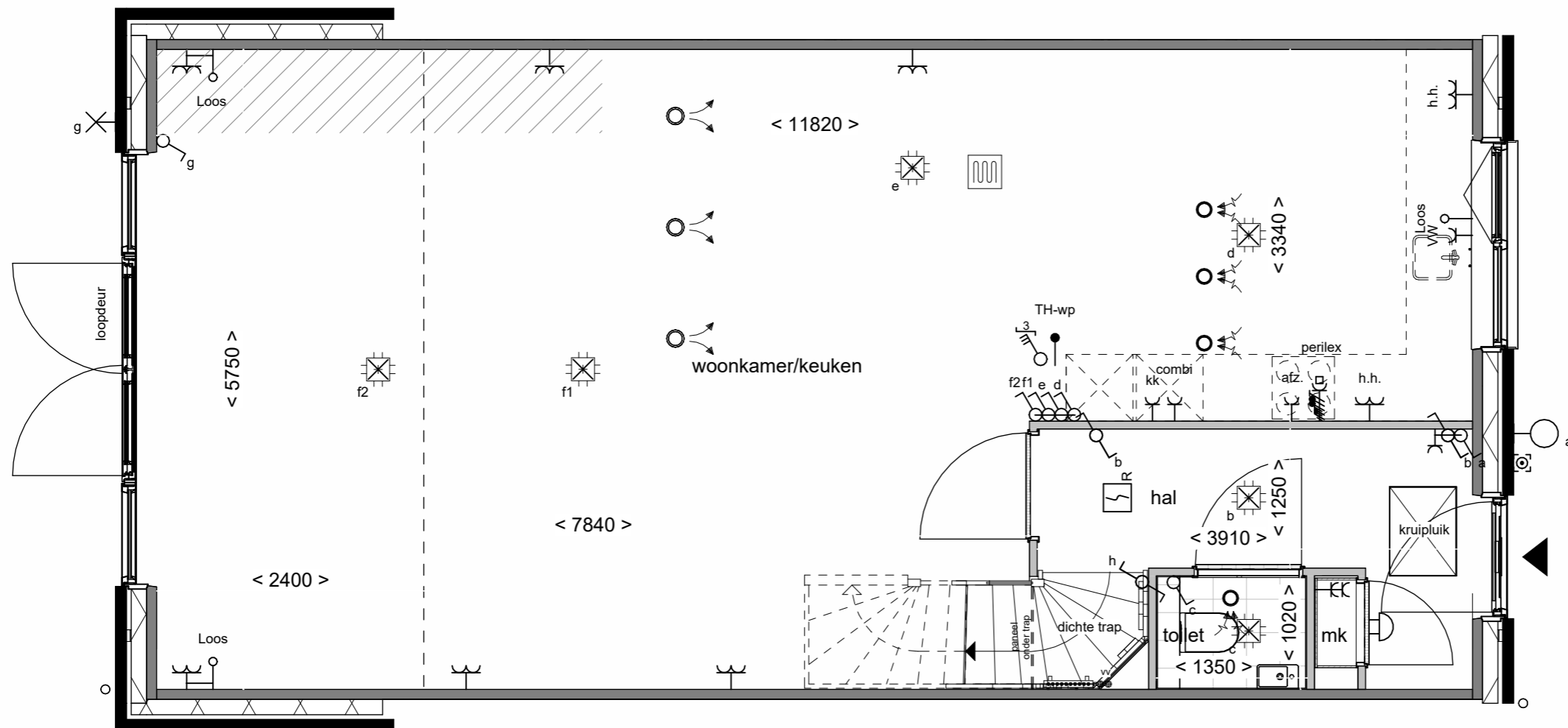

Achtergevel schaal 1:100



STEENBRUGGE
DEVENTER



VAN WIJNEN
Openslaande
deuren 2 zijlichten

Tekening: Openslaande deuren 2 zijlichten

Woningtype: C60

Bouwnummer: -

Optienummer: 1.A.X.62

Bladformaat: A3

Schaal: 1:50 / 1:100

Datum: 26-11-2024

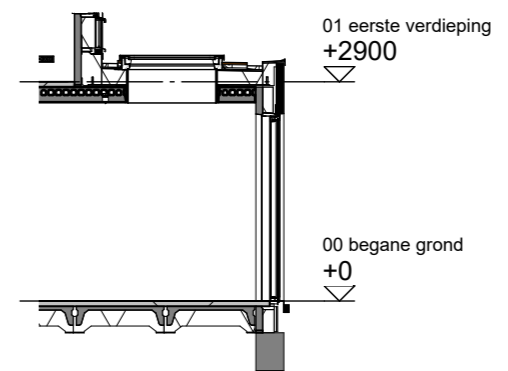
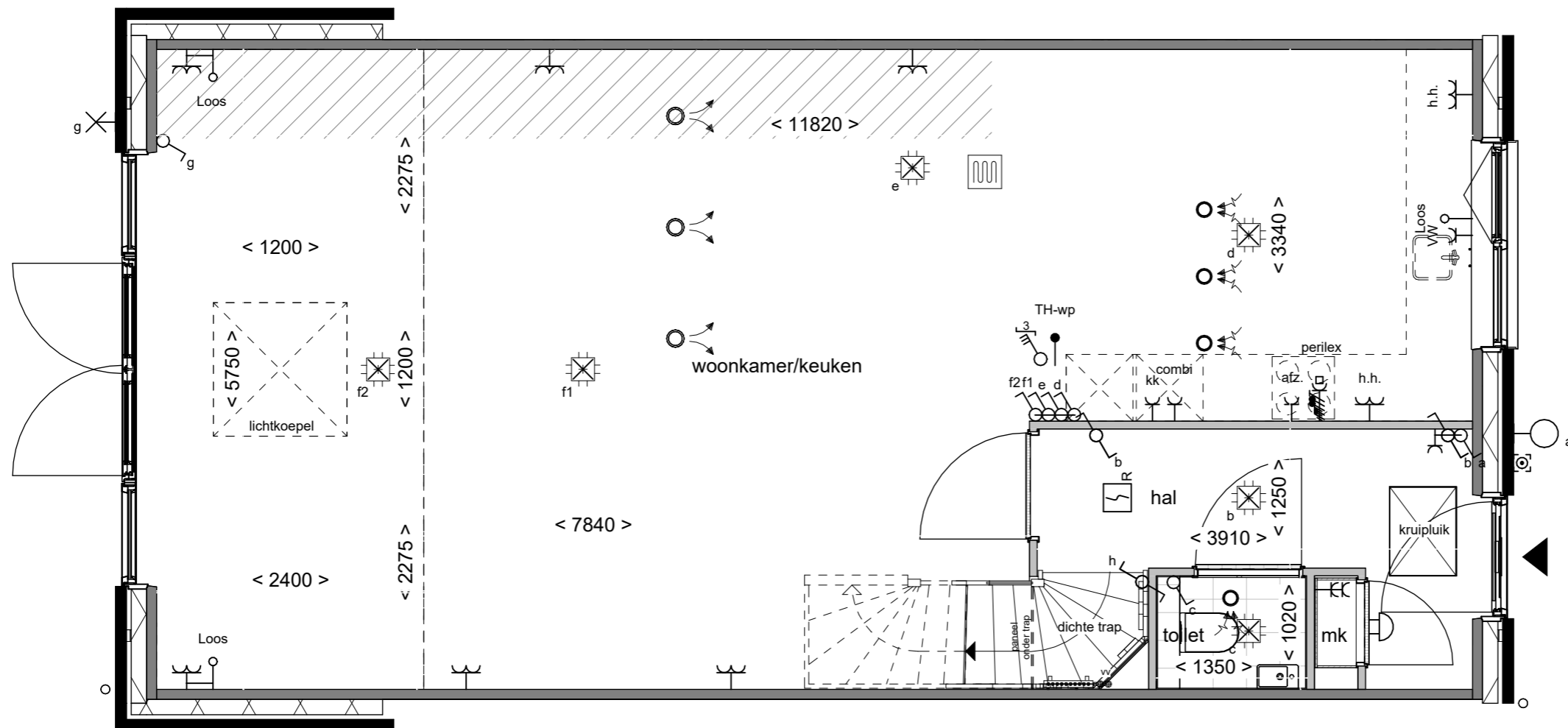

Doorsnede schaal 1:100



STEENBRUGGE
DEVENTER



VAN WIJNEN
Lichtkoepel in
uitbouw 240cm

Tekening: _____

Woningtype: C60 _____

Bouwnummer: - _____

Optienummer: 1.B.X.10 _____

Bladformaat: A3 _____

Schaal: 1:50 / 1:100 _____

Datum: 26-11-2024 _____

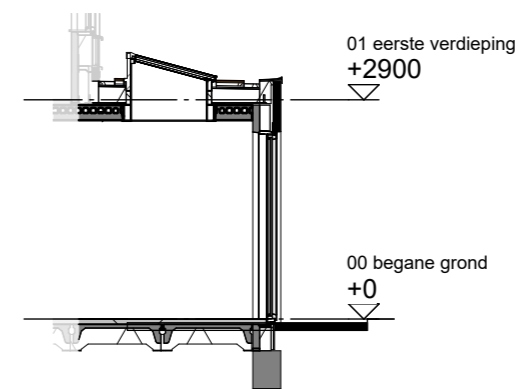
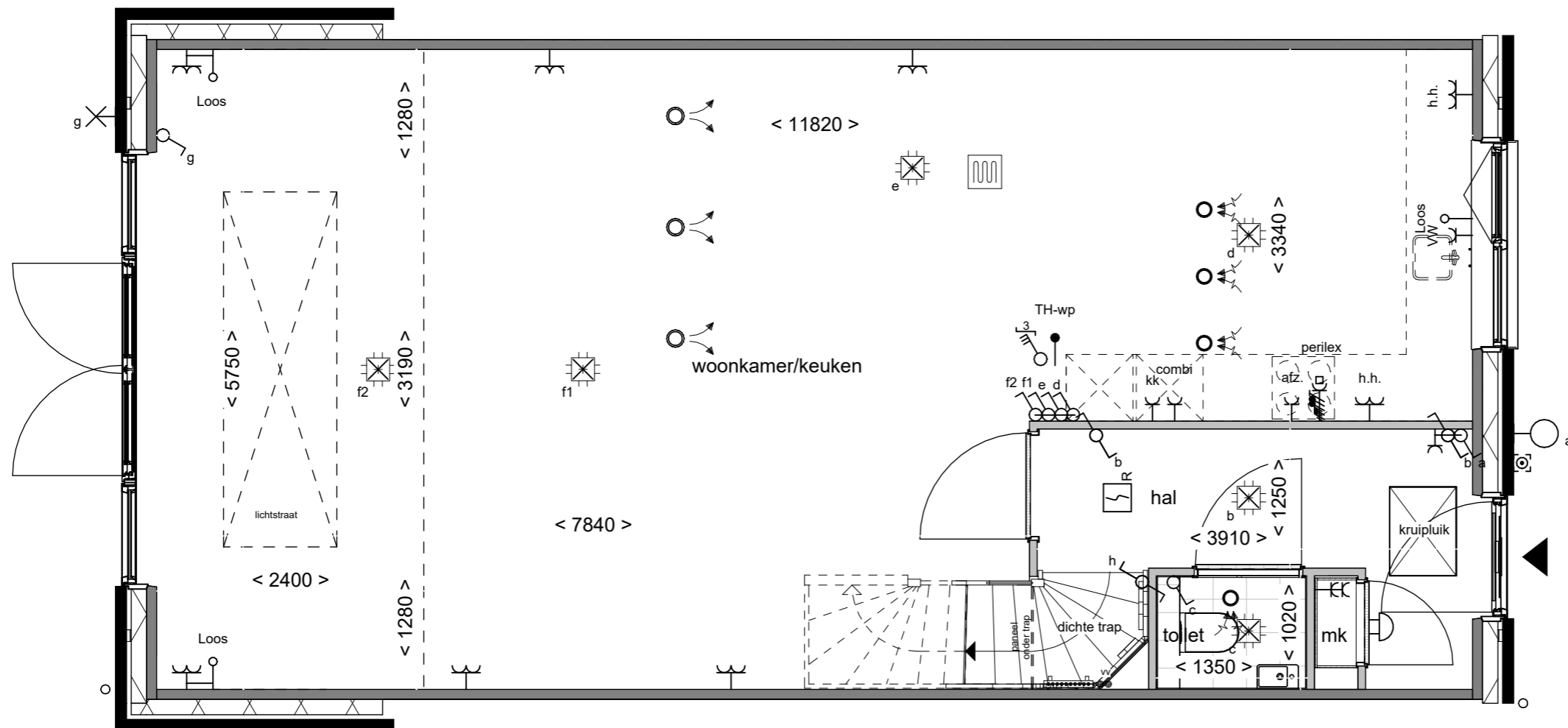

Doorsnede schaal 1:100



STEENBRUGGE
DEVENTER



VAN WIJNEN
Lichtstraat in
uitbouw 240cm

Tekening:

Woningtype: C60

Bouwnummer: -

Optienummer: 1.B.X.14

Bladformaat: A3

Schaal: 1:50 / 1:100

Datum: 26-11-2024

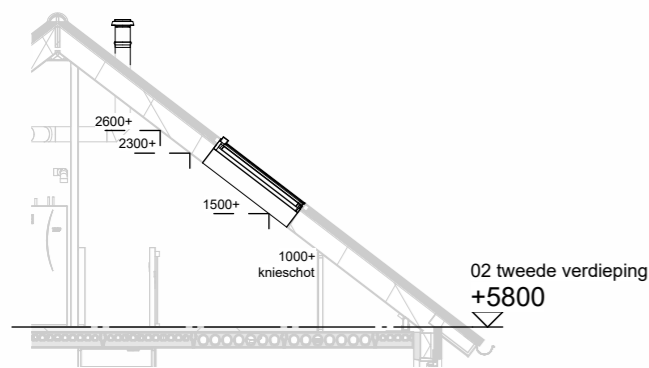
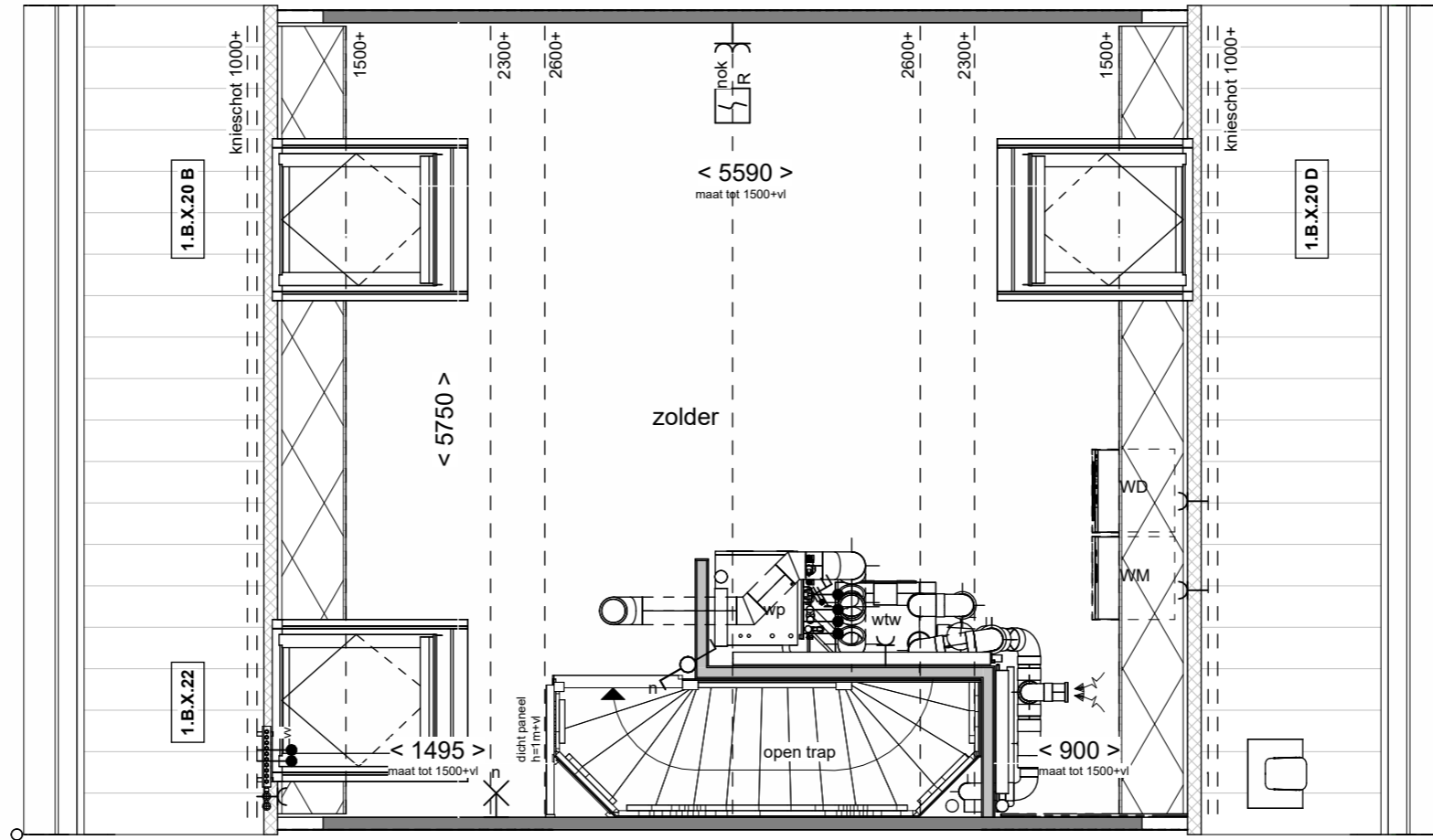

Doorsnede schaal 1:100

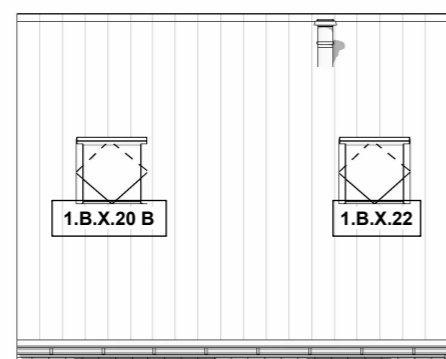

Achtergevel schaal 1:100

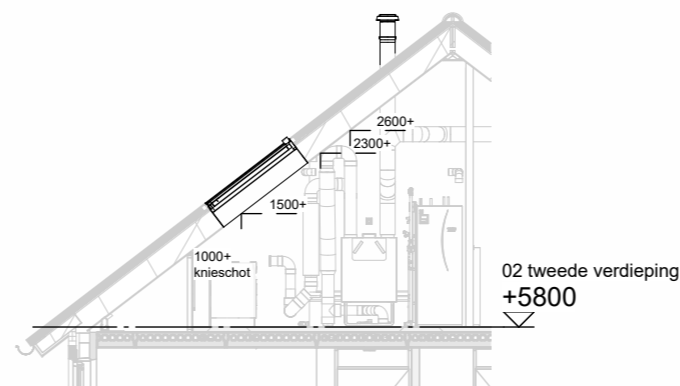

Doorsnede schaal 1:100

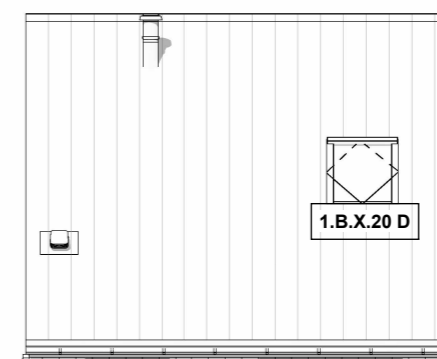

Voorgevel schaal 1:100



STEENBRUGGE
DEVENTER



Dakramen voor-
en achtergevel

Tekening:

Woningtype: C60

Bouwnummer: -

Optienummer: 1.B.X.20 / 1.B.X.22

Bladformaat: A3

Schaal: 1:50 / 1:100

Datum: 26-11-2024

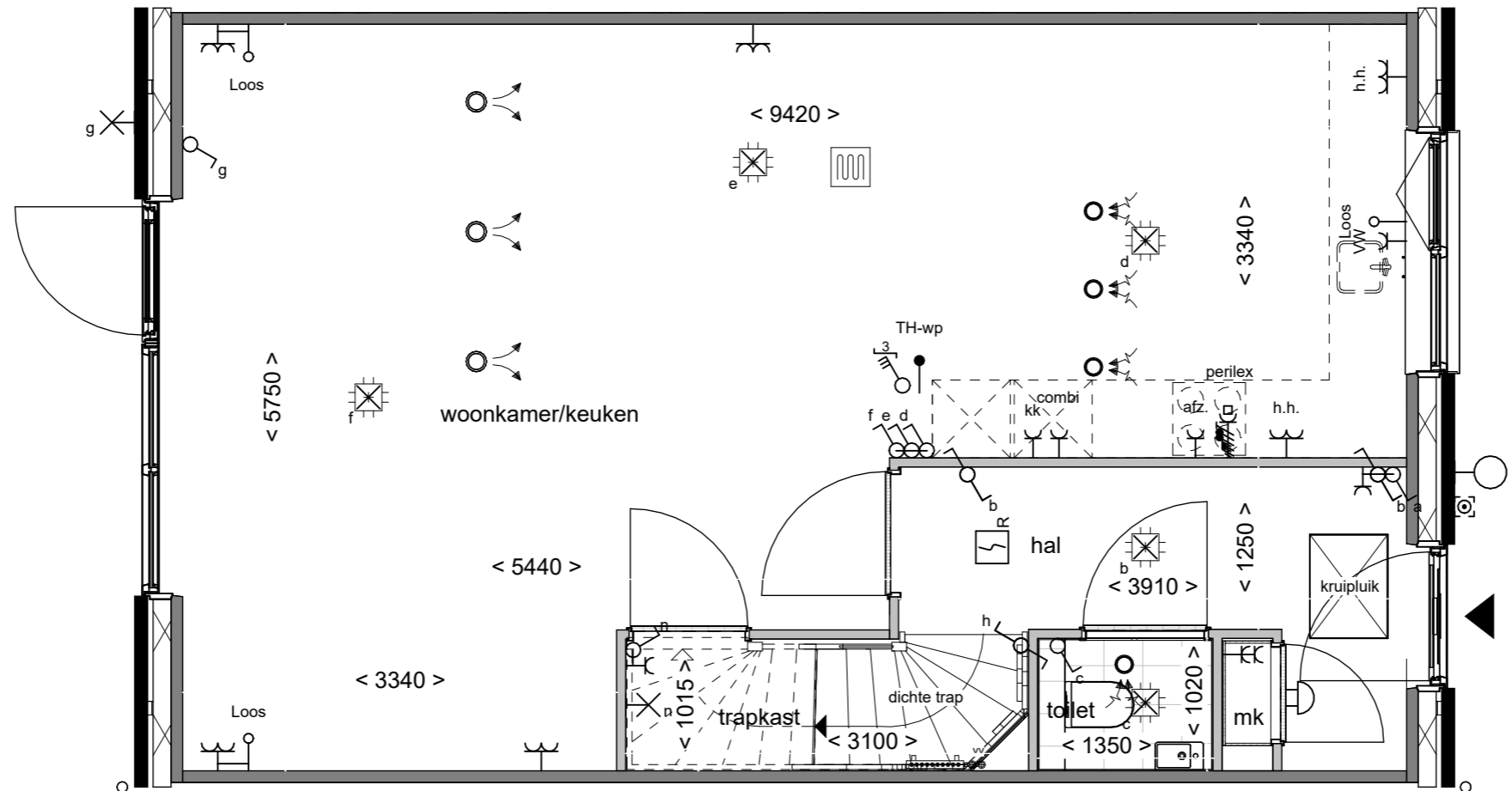

STEENBRUGGE
DEVENTER



Trapkast

Tekening:

Woningtype: C60

Bouwnummer: -

Optienummer: 1.C.C.10

Bladformaat: A3

Schaal: 1:50

Datum: 26-11-2024

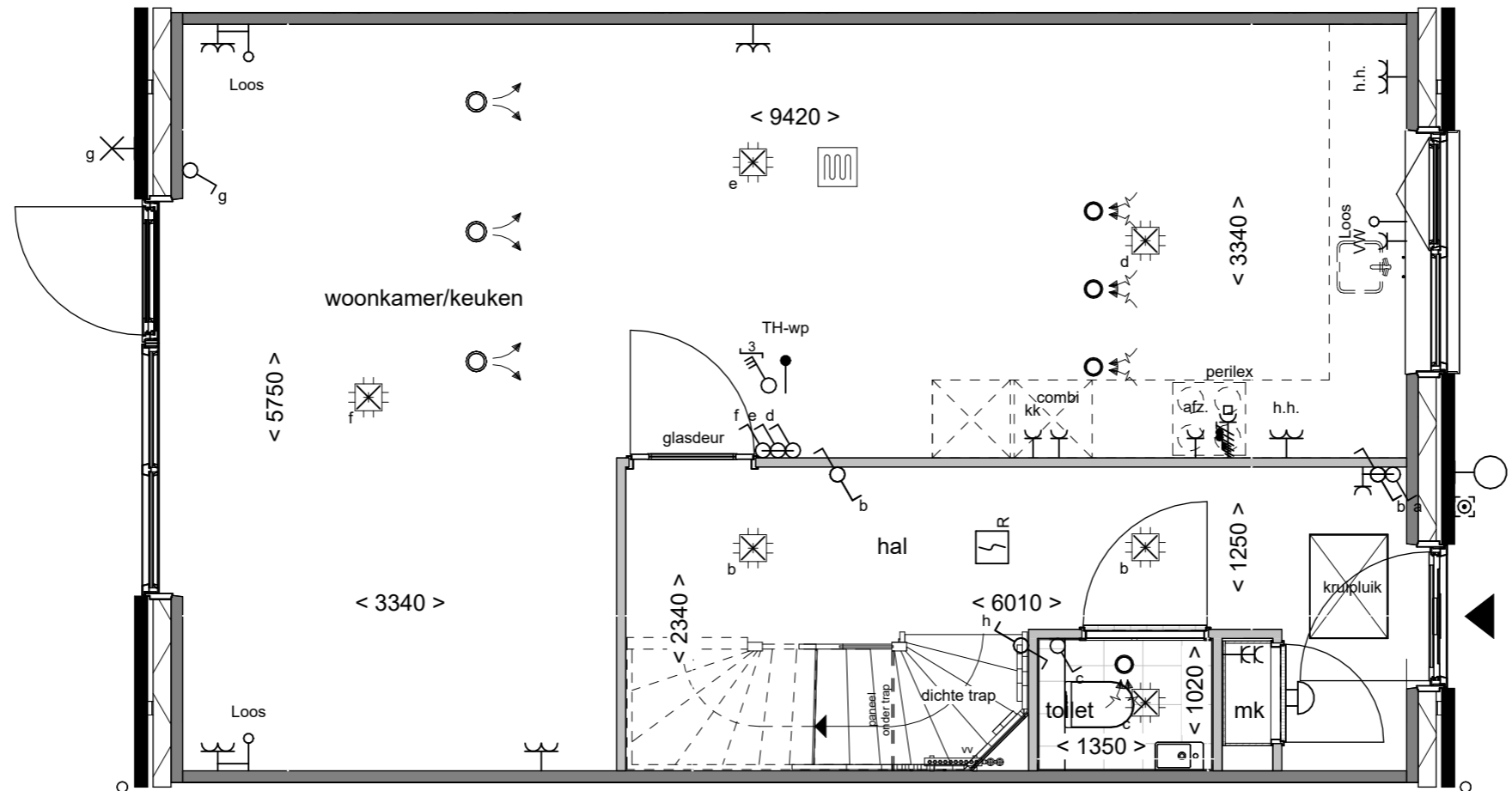

STEENBRUGGE
DEVENTER



Tekening: Vergroten hal met glasdeur

Woningtype: C60

Bouwnummer: -

Optienummer: 1.C.C.12

Bladformaat: A3

Schaal: 1:50

Datum: 26-11-2024

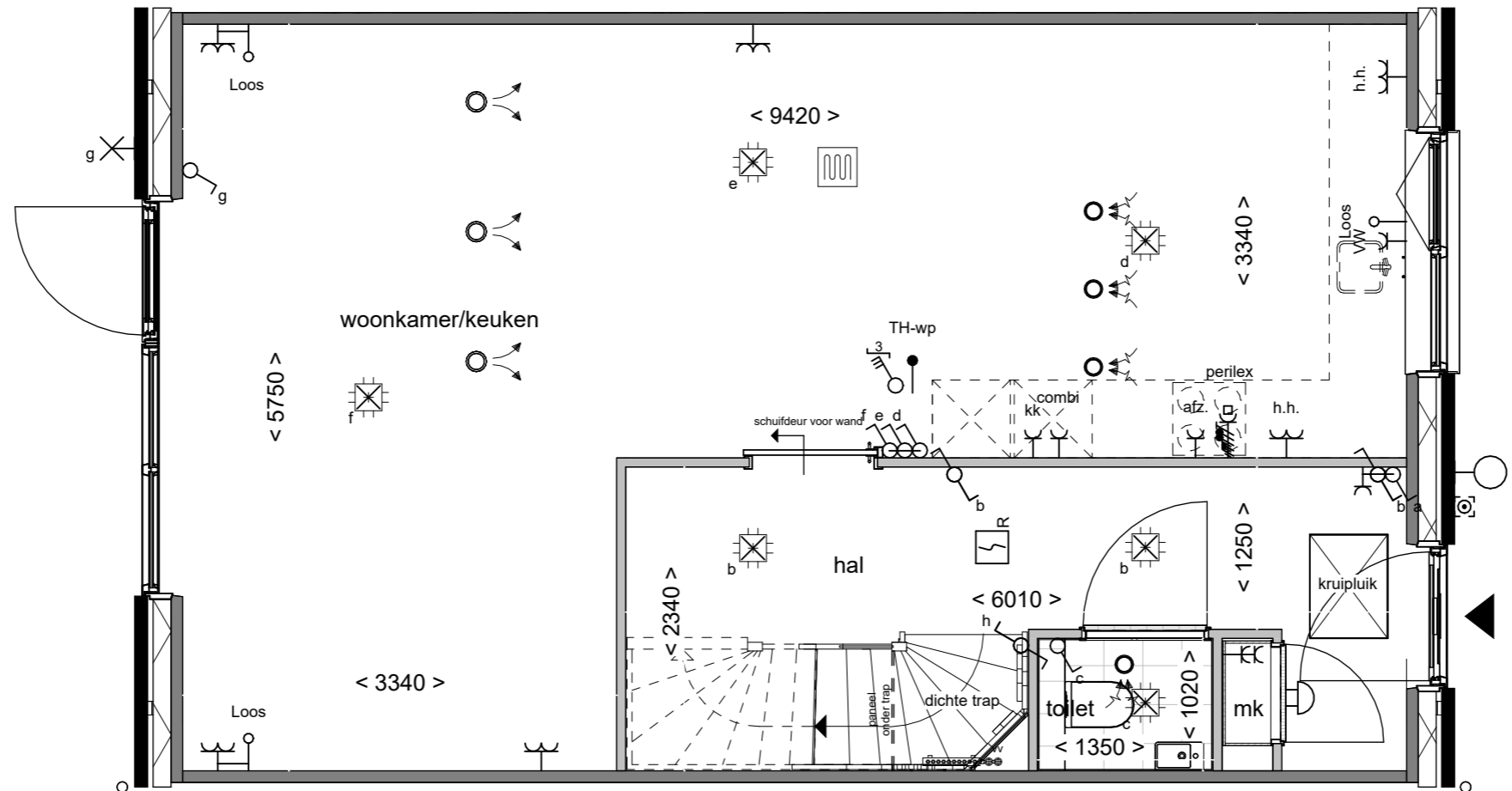

STEENBRUGGE
DEVENTER



Tekening: Schuifdeur voor de wand

Woningtype: C60

Bouwnummer: -

Optienummer: 1.C.C.12 - 2.L.0.24

Bladformaat: A3

Schaal: 1:50

Datum: 26-11-2024

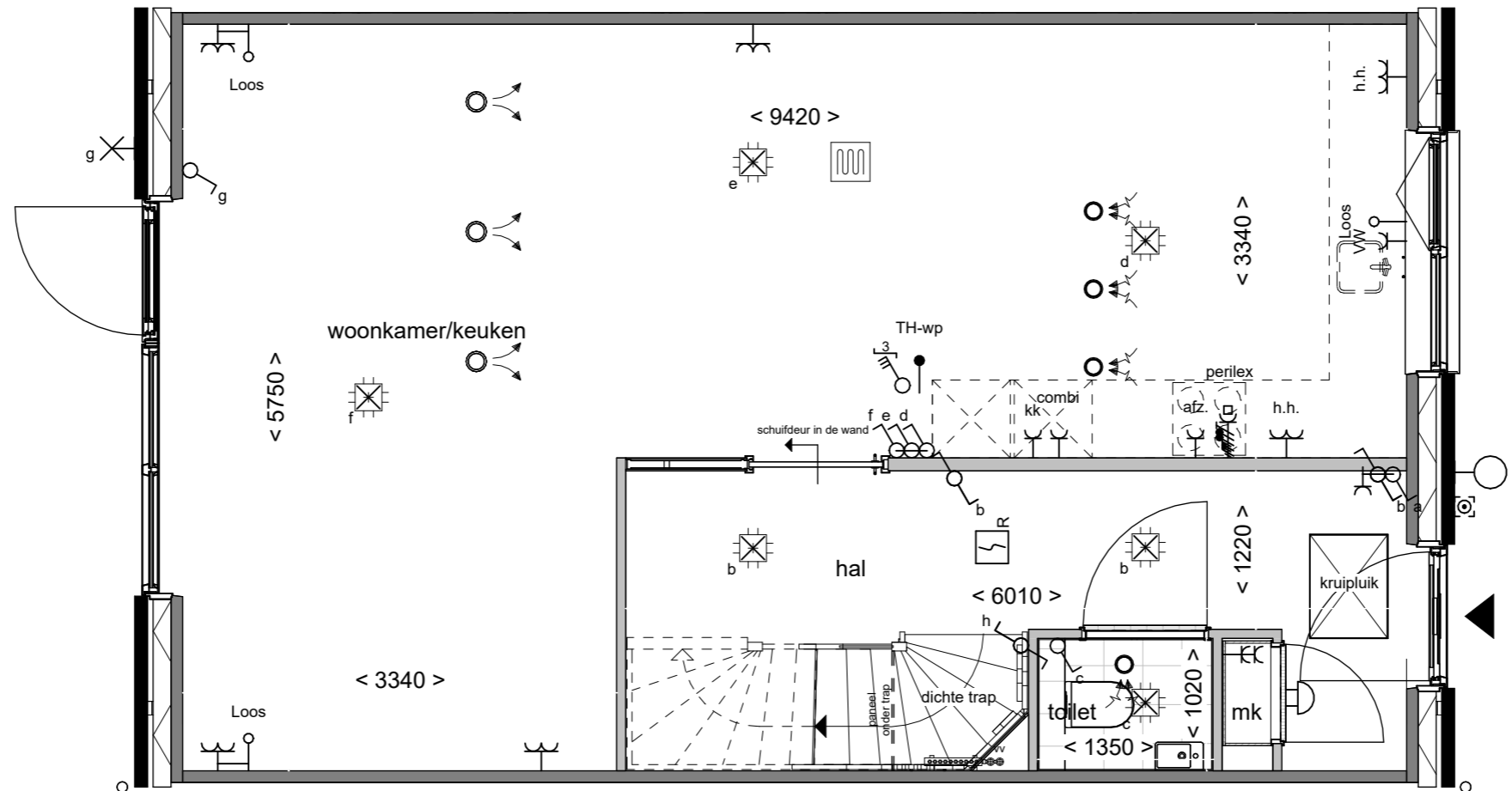

STEENBRUGGE
DEVENTER



**Schuifdeur in de
wand**

Tekening: **Schuifdeur in de wand**

Woningtype: **C60**

Bouwnummer: **-**

Optienummer: **1.C.C.12 - 2.L.0.26**

Bladformaat: **A3**

Schaal: **1:50**

Datum: **26-11-2024**

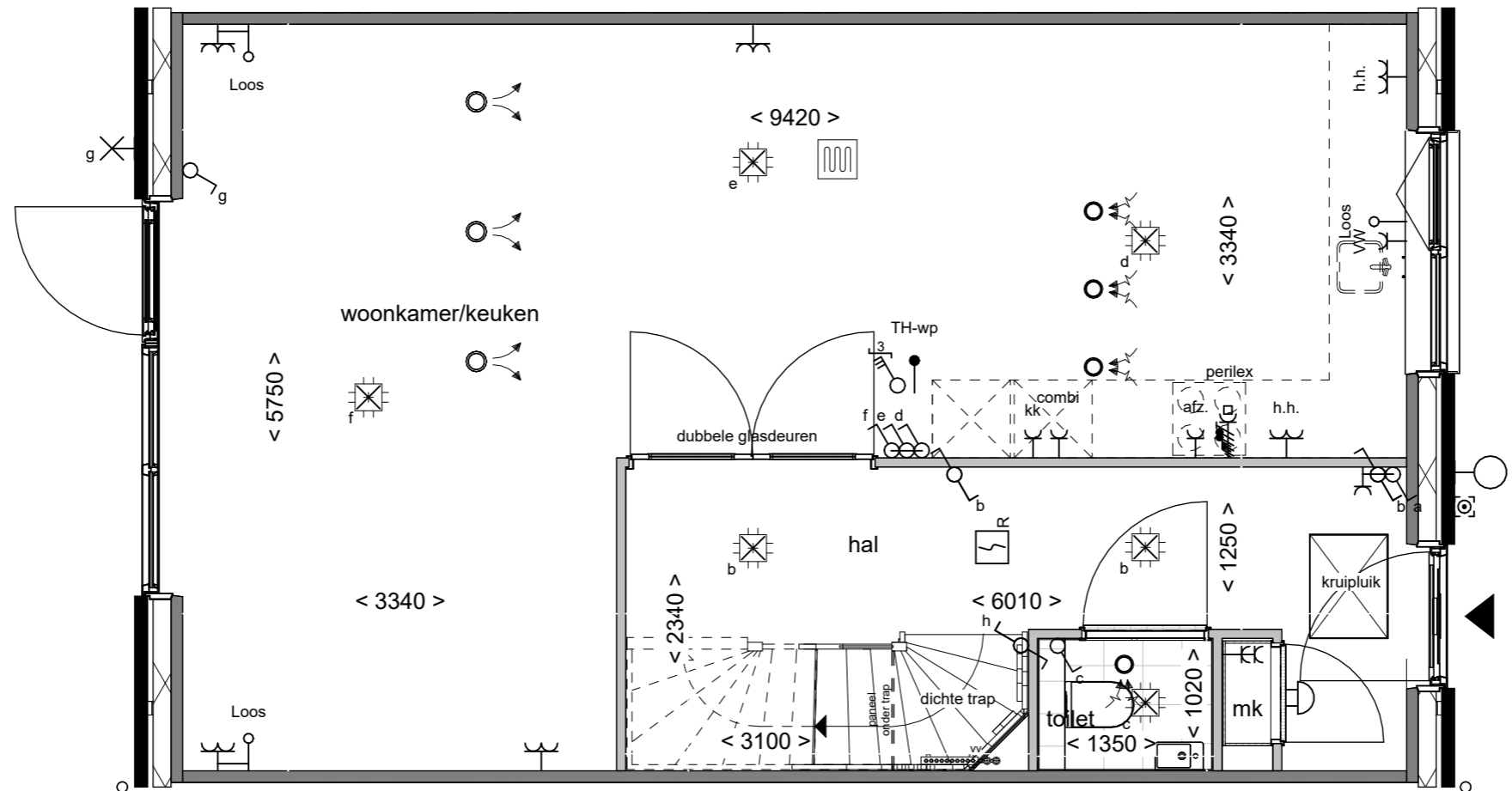

STEENBRUGGE
DEVENTER



VAN WIJNEN
Vergroten hal met
2 glasdeuren

Tekening:

Woningtype: C60

Bouwnummer: -

Optienummer: 1.C.C.14

Bladformaat: A3

Schaal: 1:50

Datum: 26-11-2024

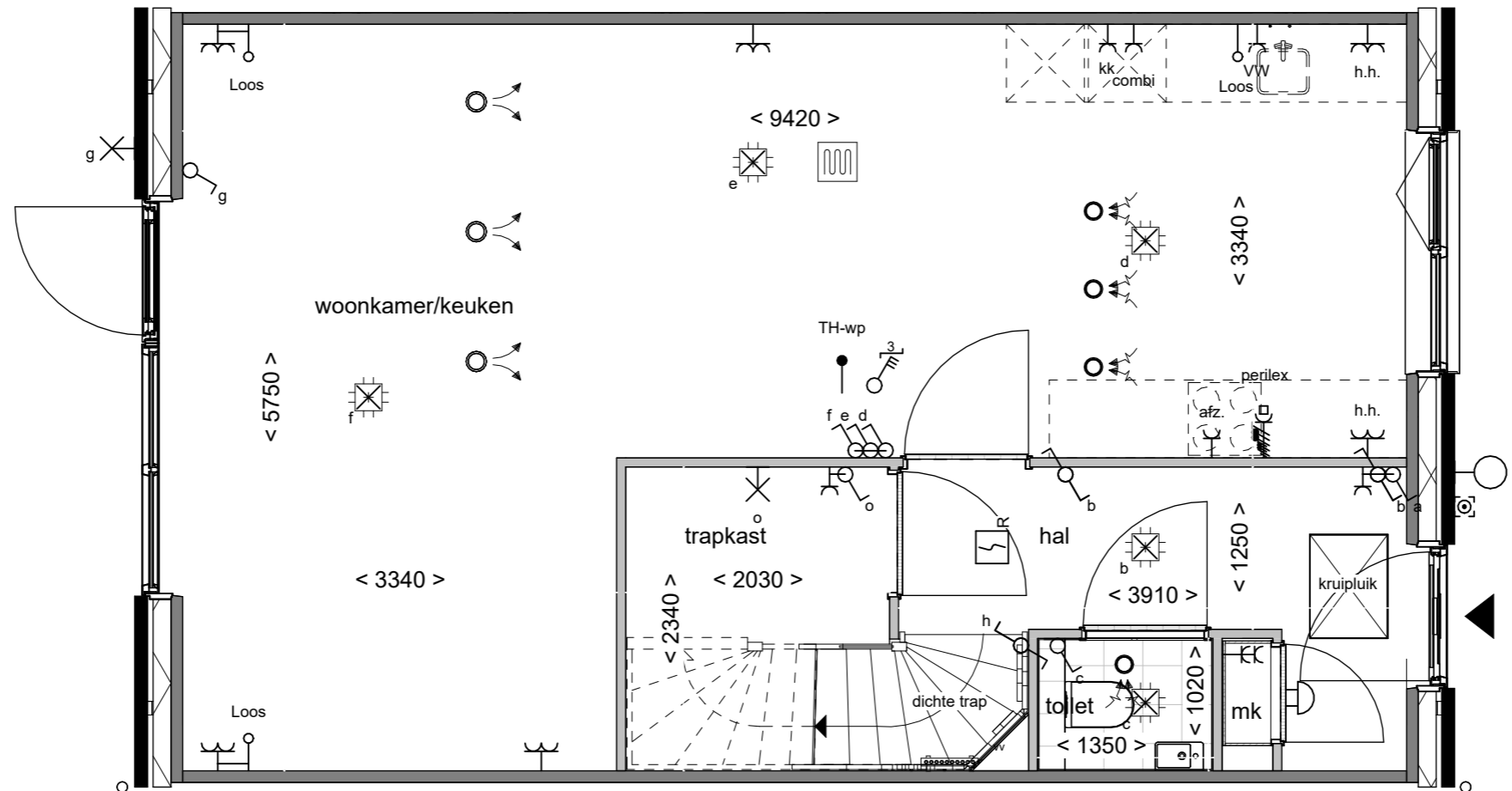

STEENBRUGGE
DEVENTER



VAN WIJNEN
Vergroten trapkast

Tekening: _____

Woningtype: C60

Bouwnummer: -

Optienummer: 1.C.C.16

Bladformaat: A3

Schaal: 1:50

Datum: 26-11-2024

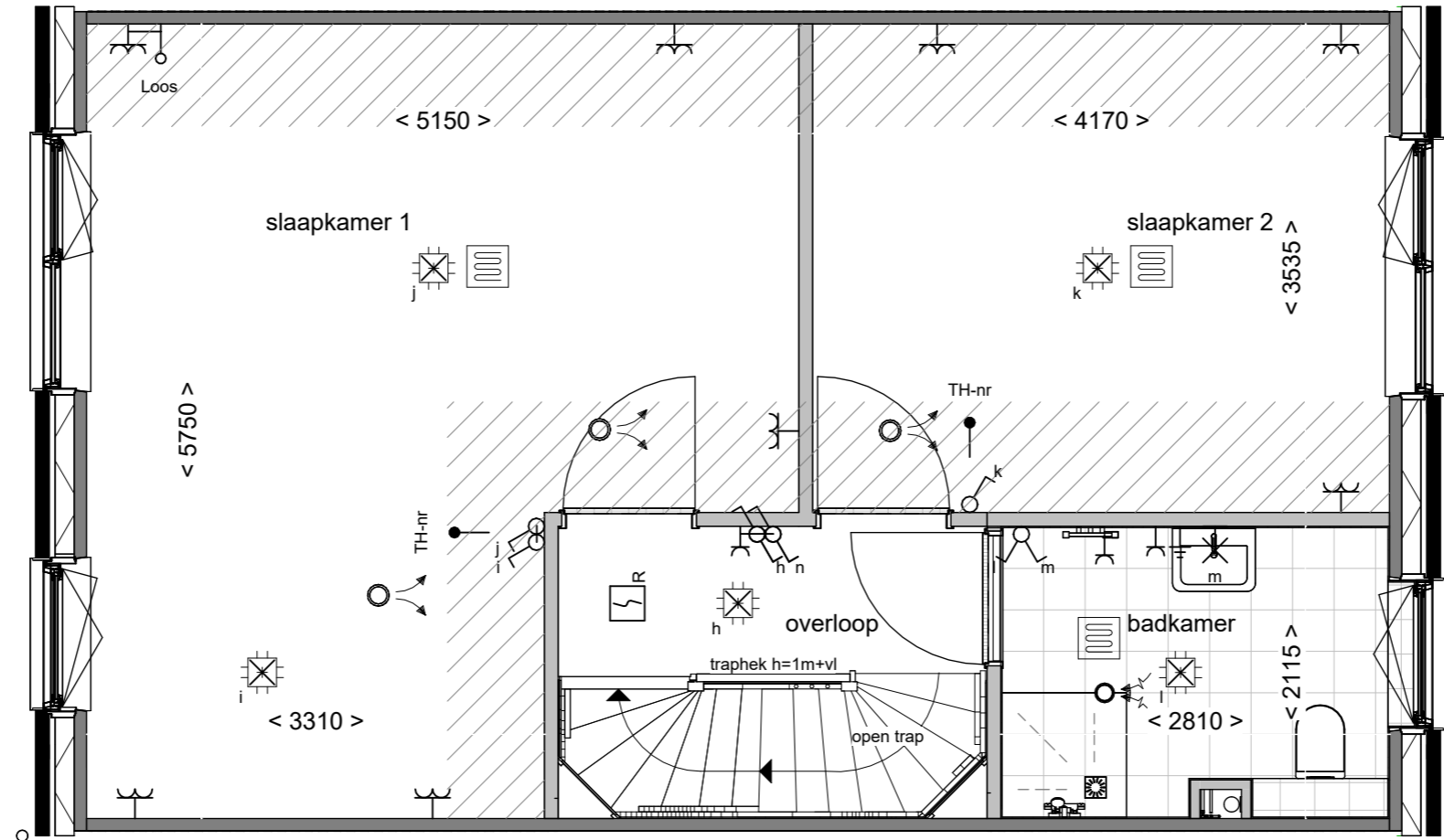

STEENBRUGGE
DEVENTER



VAN WIJNEN
Samenvoegen
slaapk. achterzijde

Tekening: Woningtype: C60

Bouwnummer: -

Optienummer: 1.C.C.32

Bladformaat: A3

Schaal: 1:50

Datum: 26-11-2024

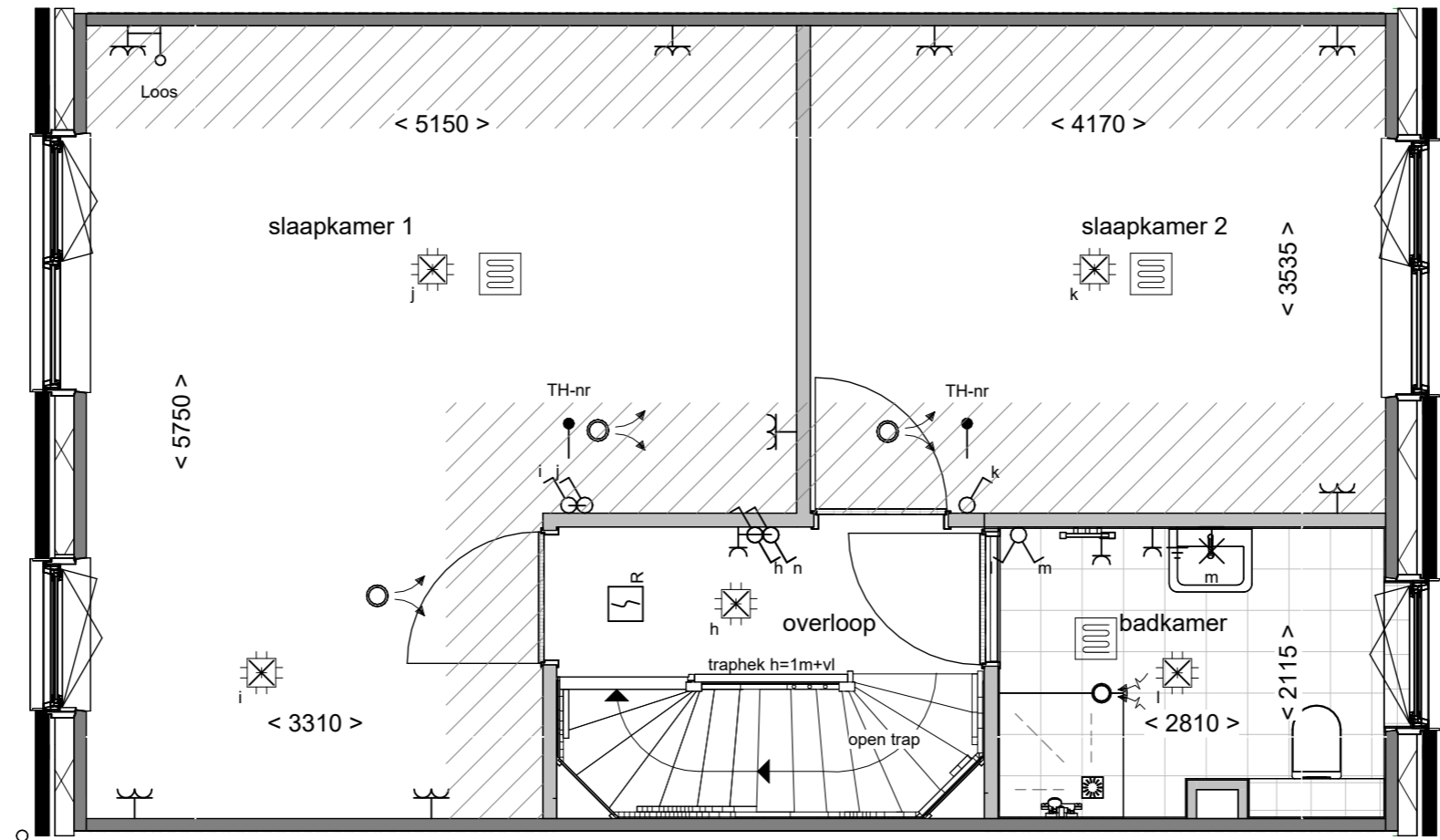

STEENBRUGGE
DEVENTER



Samenvoegen
slaapk. achterzijde

Tekening:

Woningtype: C60

Bouwnummer: -

Optienummer: 1.C.C.33

Bladformaat: A3

Schaal: 1:50

Datum: 26-11-2024

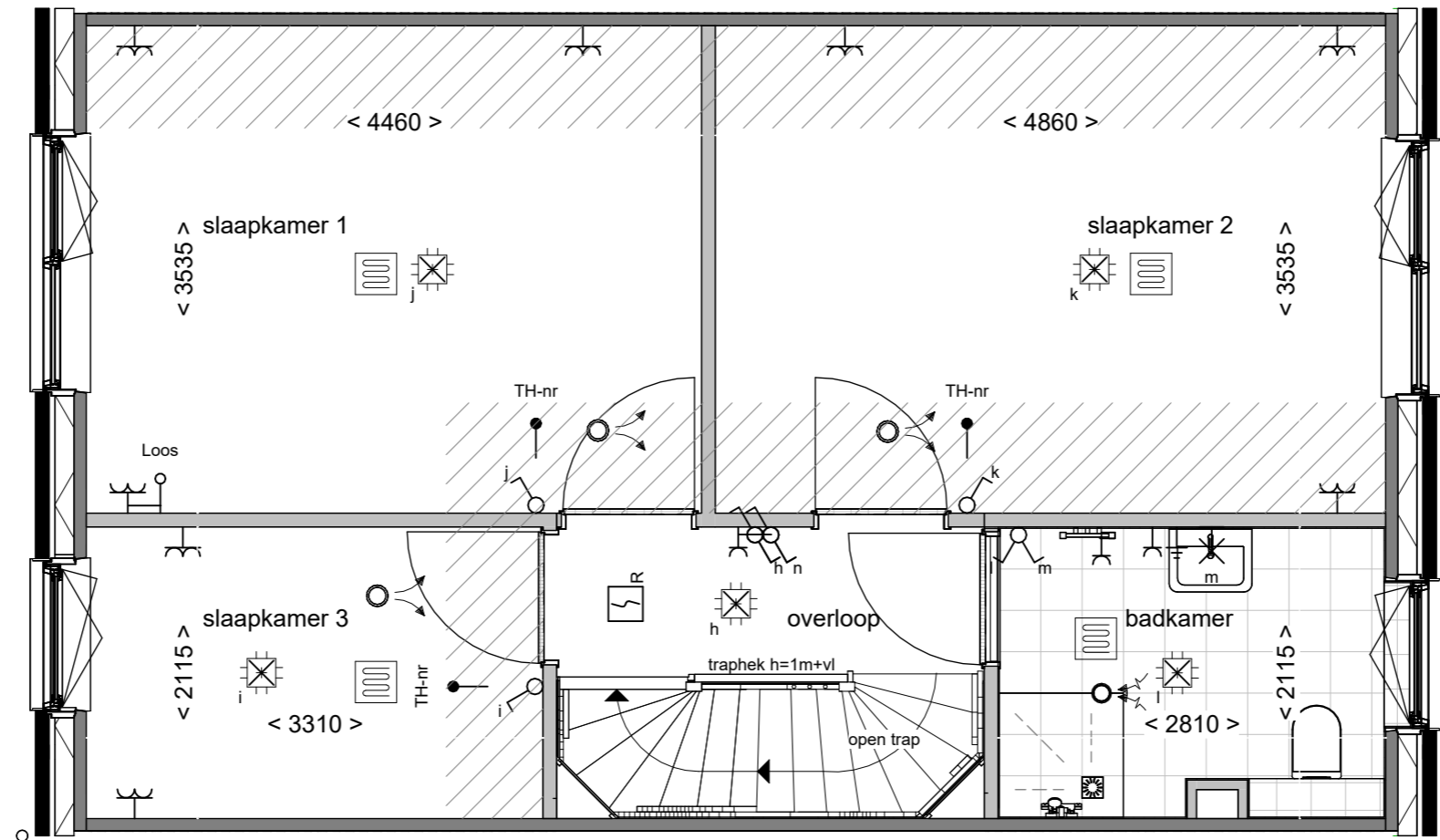

STEENBRUGGE
DEVENTER



Vergroten
slaapkamer 2

Tekening:

Woningtype: C60

Bouwnummer: -

Optienummer: 1.C.C.34

Bladformaat: A3

Schaal: 1:50

Datum: 26-11-2024

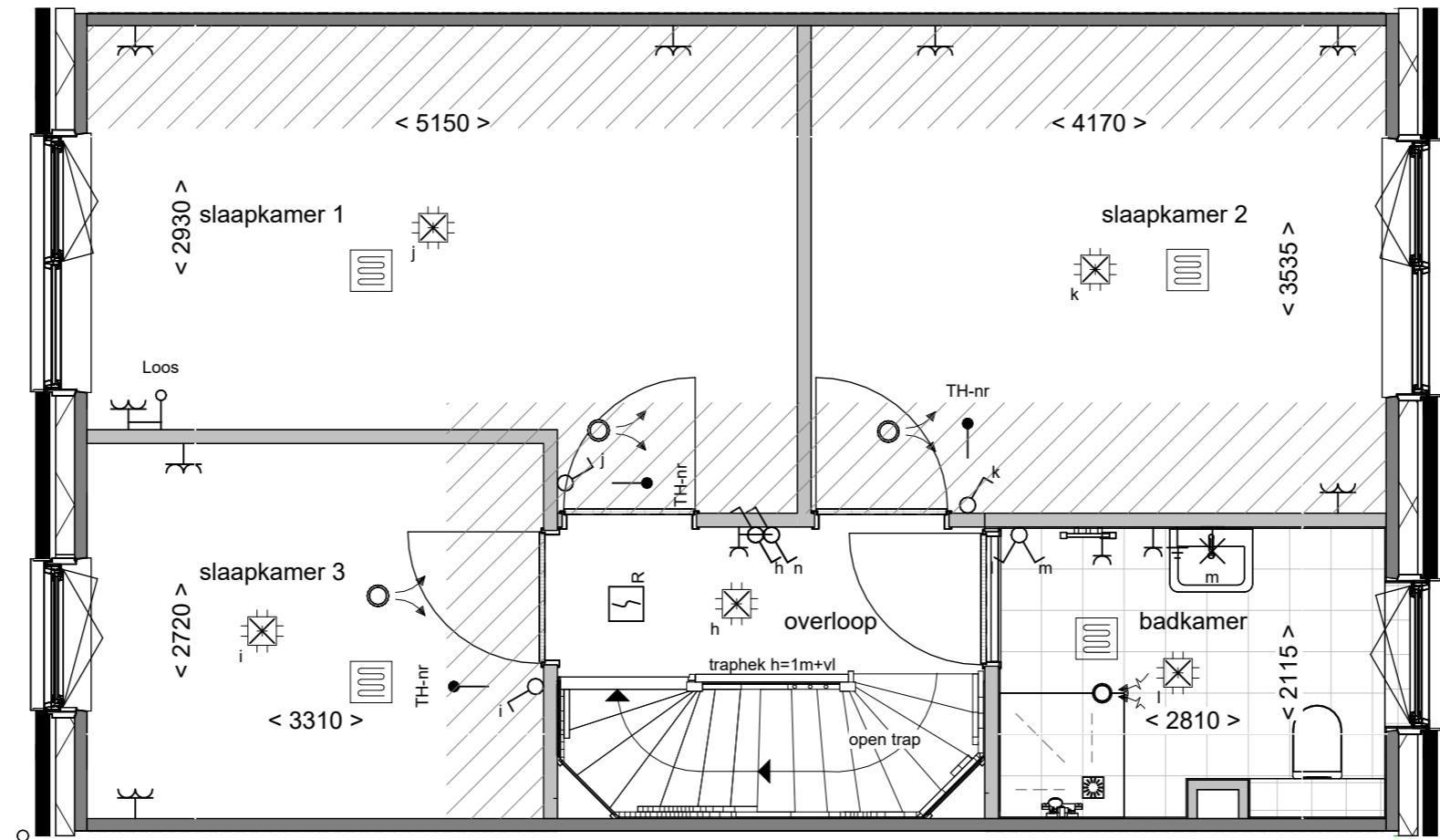

STEENBRUGGE
DEVENTER



Vergroten
slaapkamer 3

Tekening:

Woningtype: C60

Bouwnummer: -

Optienummer: 1.C.C.36

Bladformaat: A3

Schaal: 1:50

Datum: 26-11-2024

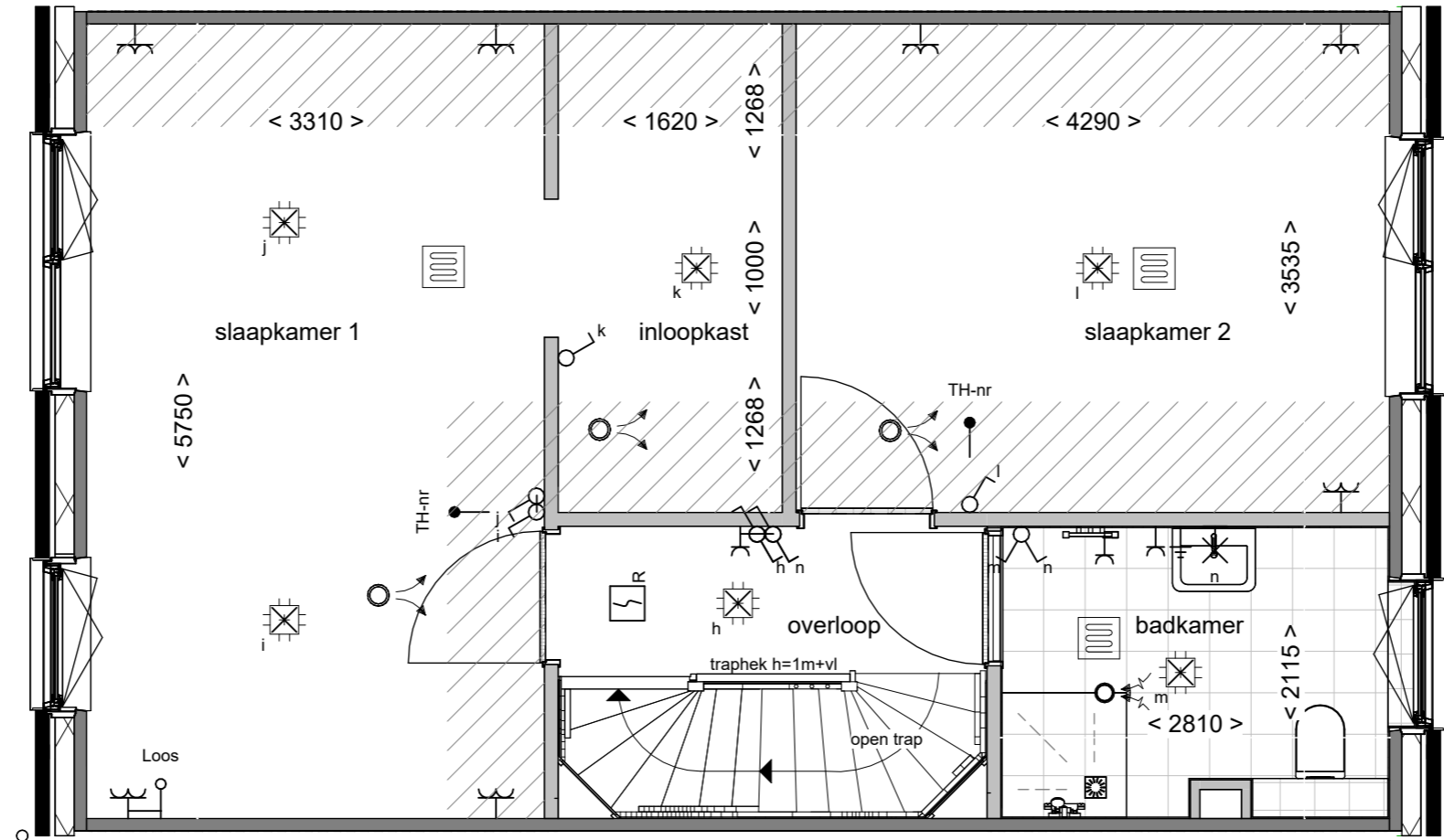

STEENBRUGGE
DEVENTER



Tekening: Inloopkast in
slaapk. achterzijde

Woningtype: C60

Bouwnummer: -

Optienummer: 1.C.C.38

Bladformaat: A3

Schaal: 1:50

Datum: 26-11-2024

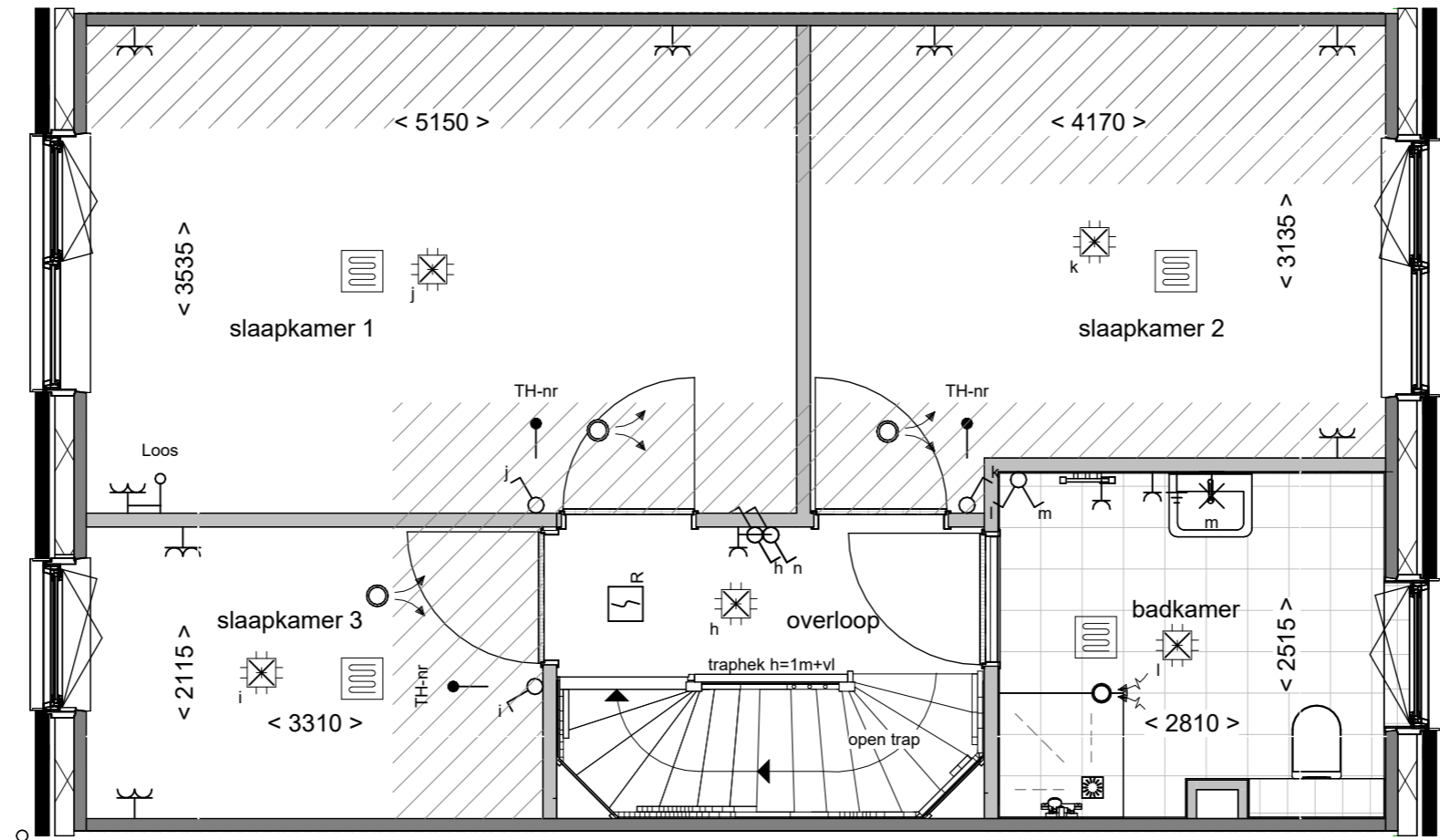

STEENBRUGGE
DEVENTER



VAN WIJNEN
Vergroten badk.
met ca. 40cm

Tekening:

Woningtype: C60

Bouwnummer: -

Optienummer: 1.C.C.40

Bladformaat: A3

Schaal: 1:50

Datum: 26-11-2024

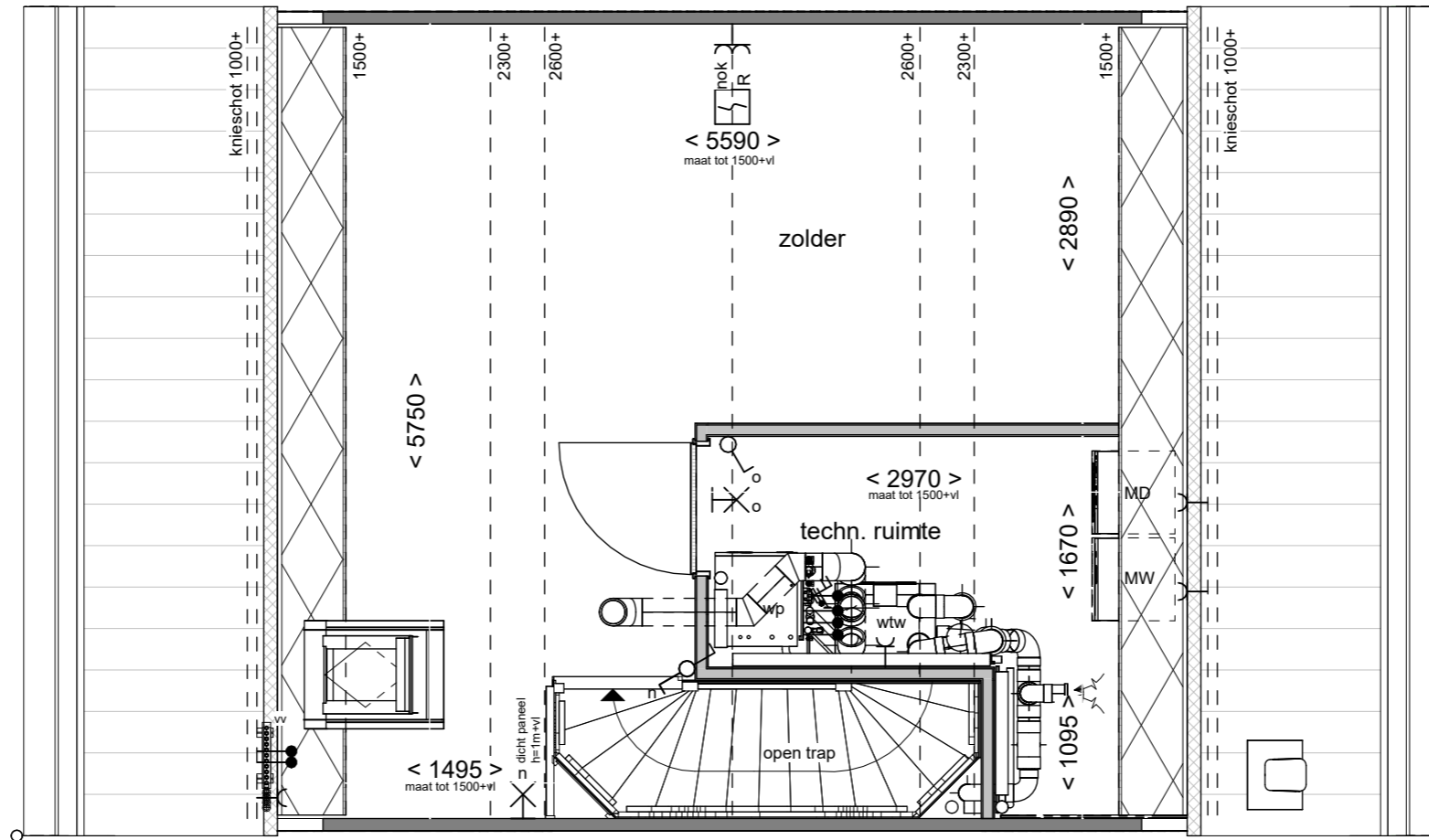

STEENBRUGGE
DEVENTER



Tekening: **Wijzigen indeling met techniekruimte**

Woningtype: **C60**

Bouwnummer: **-**

Optienummer: **1.C.C.70**

Bladformaat: **A3**

Schaal: **1:50**

Datum: **26-11-2024**

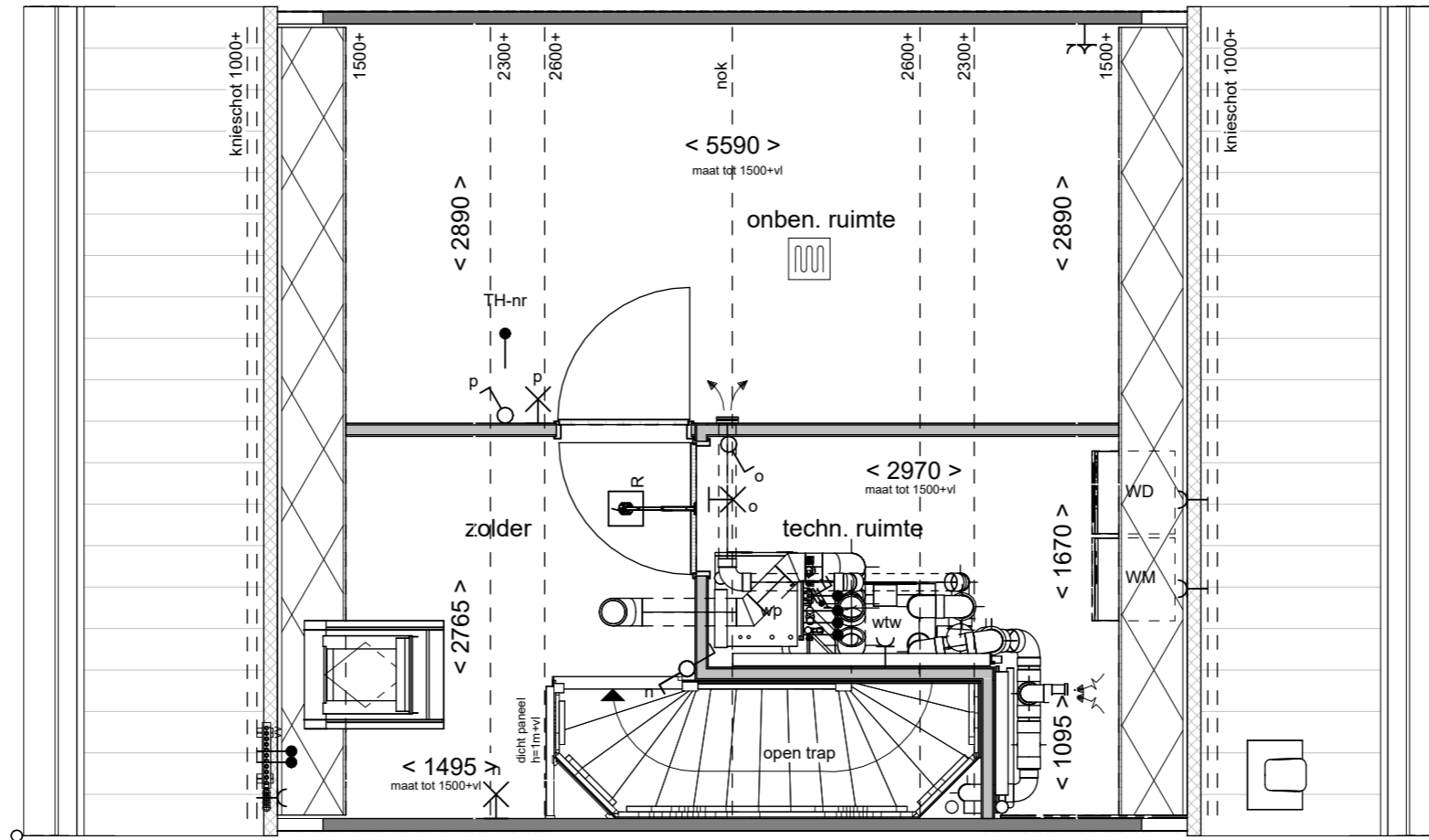

STEENBRUGGE
DEVENTER



Tekening: Indeling met techn. en onben. ruimte

Woningtype: C60

Bouwnummer: -

Optienummer: 1.C.C.72

Bladformaat: A3

Schaal: 1:50

Datum: 26-11-2024

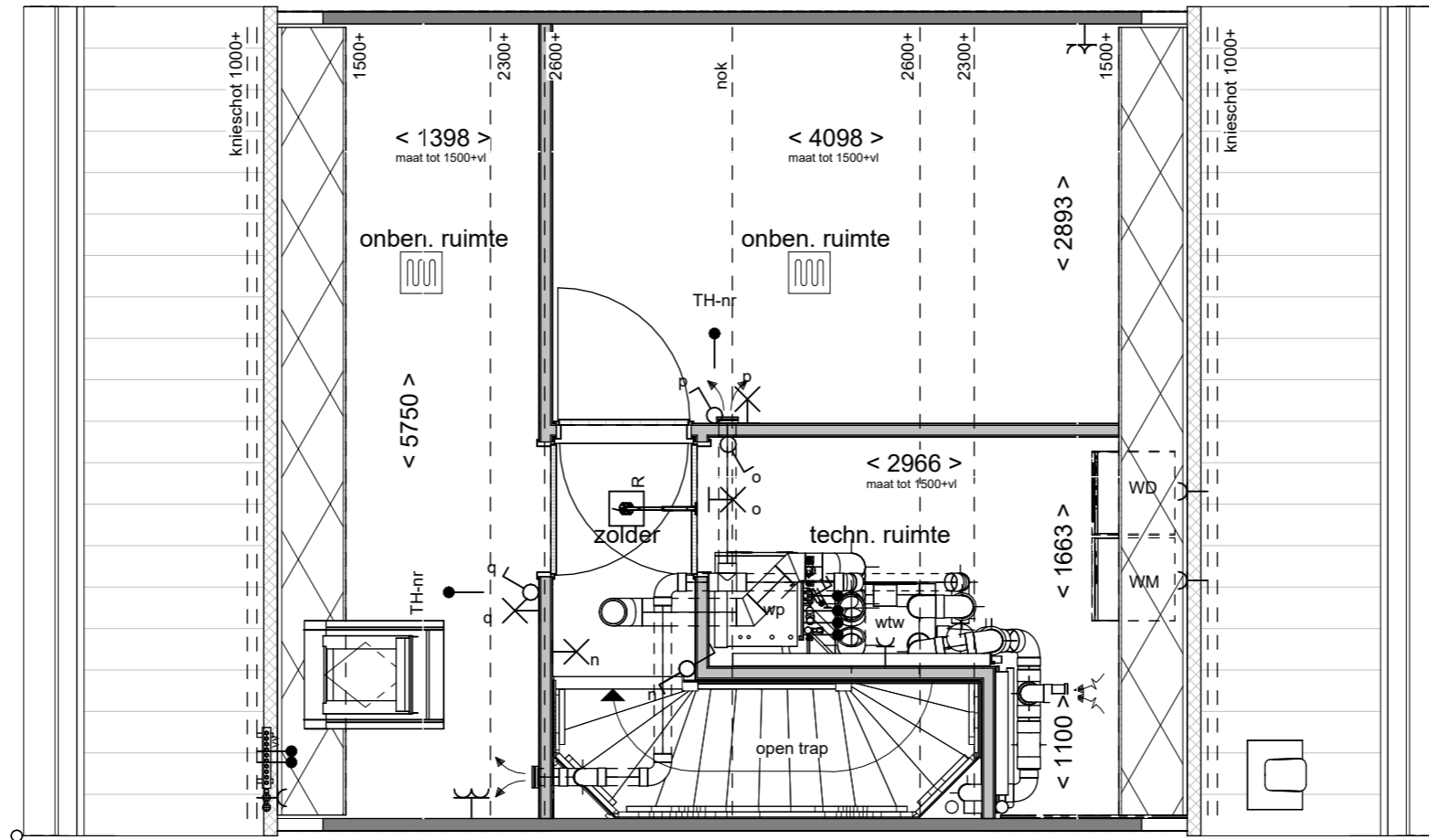

STEENBRUGGE
DEVENTER



Tekening: **Indeling techn.- en
2 onb. ruimtes**

Woningtype: **C60**

Bouwnummer: **-**

Optienummer: **1.C.C.76**

Bladformaat: **A3**

Schaal: **1:50**

Datum: **26-11-2024**

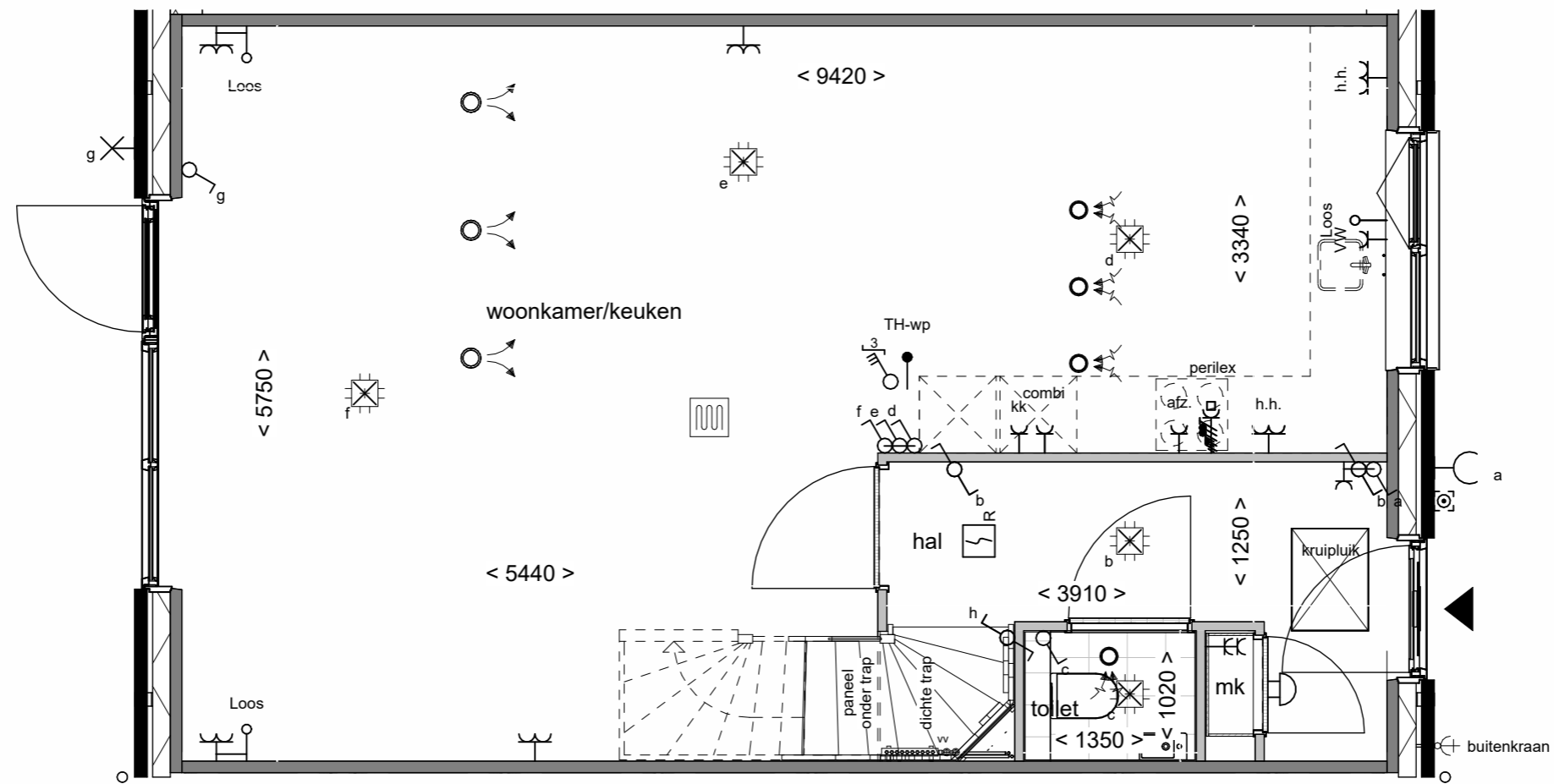

Voorgevel schaal 1:100



STEENBRUGGE
DEVENTER



vorstvrije
buitenkraan voor

Tekening: _____

Woningtype: C60

Bouwnummer: -

Optienummer: 2.K.0.40

Bladformaat: A3

Schaal: 1:50 / 1:100

Datum: 26-11-2024

