

Doorsnede schaal 1:100

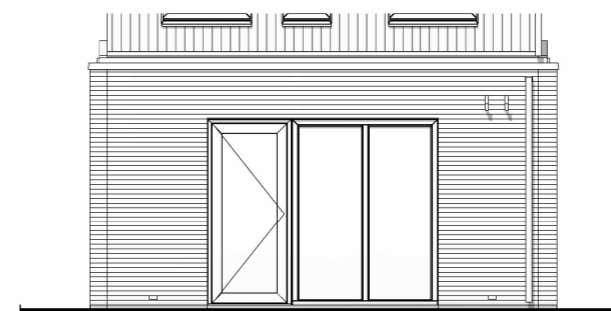

Achtergevel schaal 1:100



STEENBRUGGE
DEVENTER



Uitbouw
achtergevel 120cm

Tekening: Woningtype: C57

Bouwnummer: -

Optienummer: 1.A.X.16

Bladformaat: A3

Schaal: 1:50 / 1:100

Datum: 26-11-2024

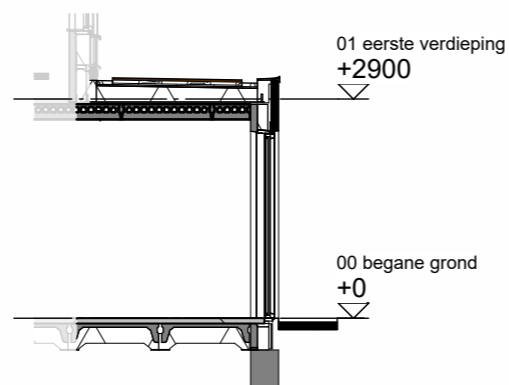
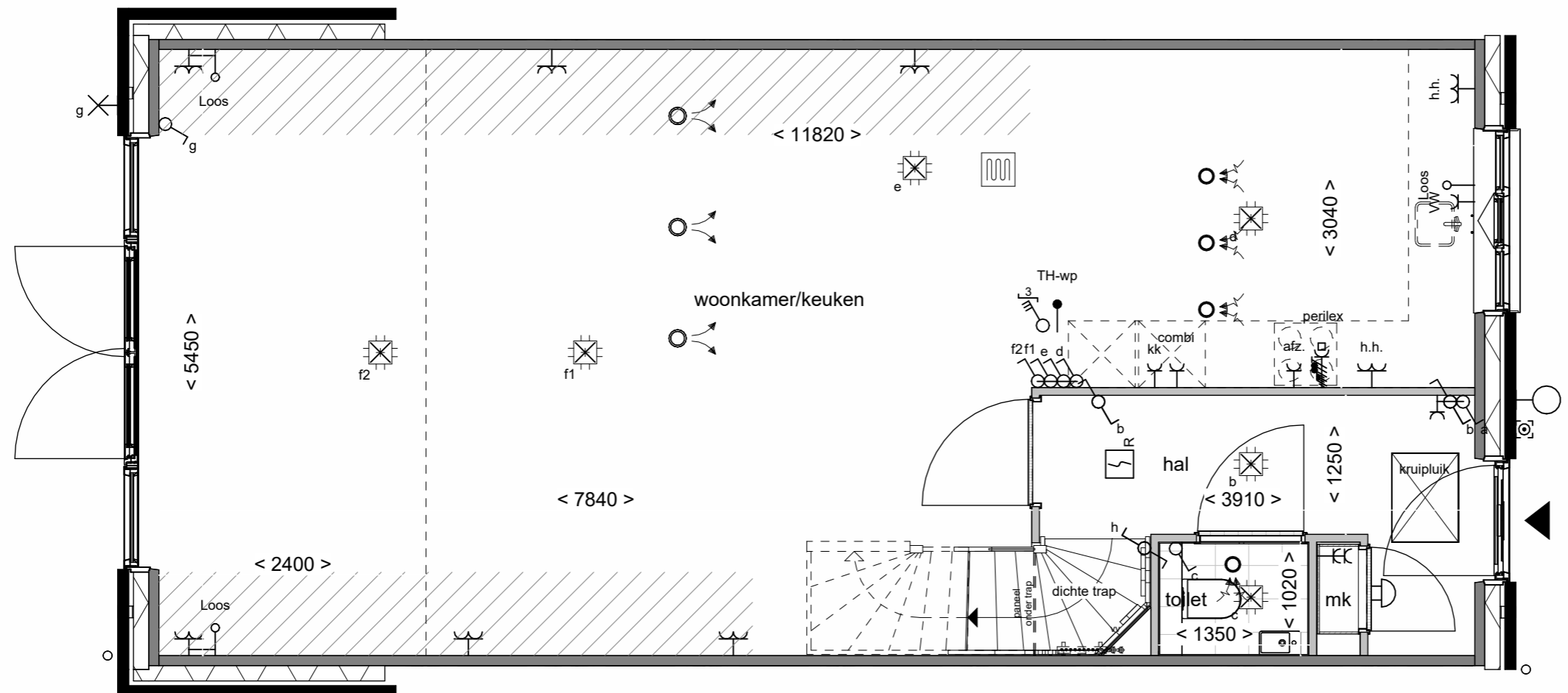

Doorsnede schaal 1:100

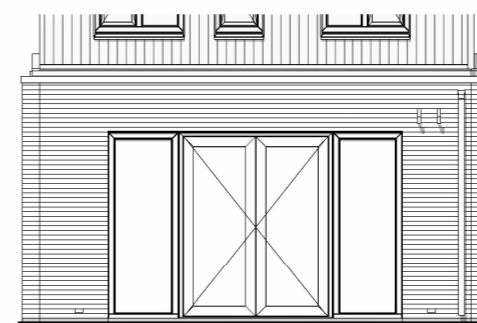

Achtergevel schaal 1:100



STEENBRUGGE
DEVENTER



Uitbouw
achtergevel 240cm

Tekening: C57

Bouwnummer: -

Optienummer: 1.A.X.36

Bladformaat: A3

Schaal: 1:50 / 1:100

Datum: 26-11-2024

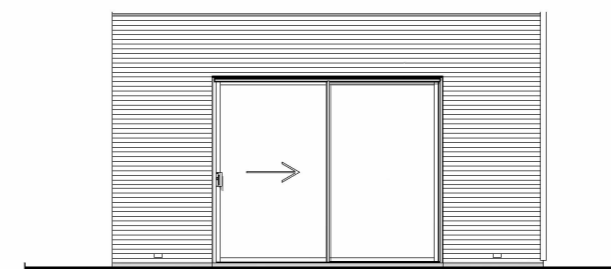
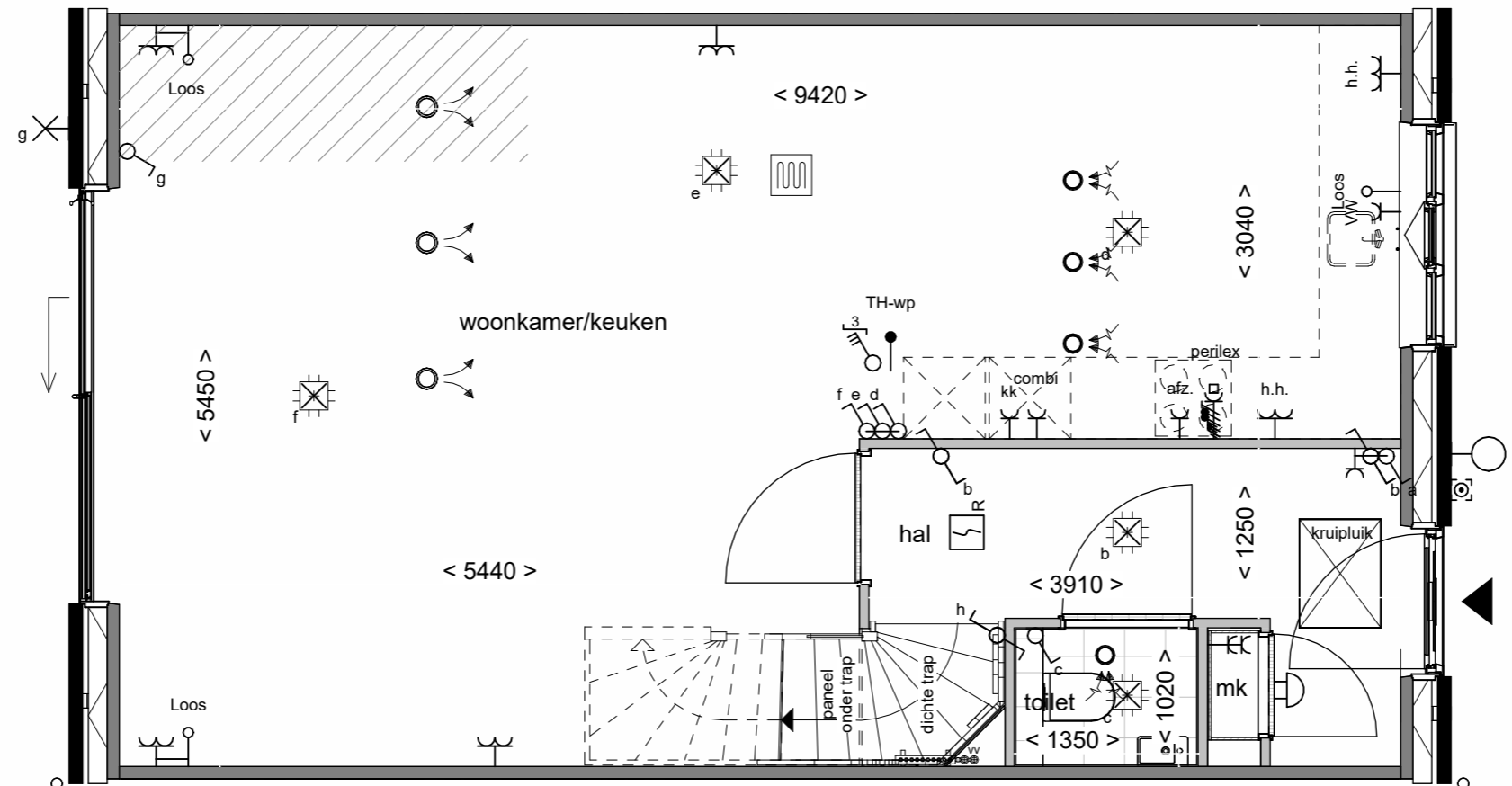

Achtergevel schaal 1:100



STEENBRUGGE
DEVENTER



VAN WIJNEN
Aluminium
schuifpui

Tekening: Aluminium schuifpui

Woningtype: C57

Bouwnummer: -

Optienummer: 1.A.X.52

Bladformaat: A3

Schaal: 1:50 / 1:100

Datum: 26-11-2024

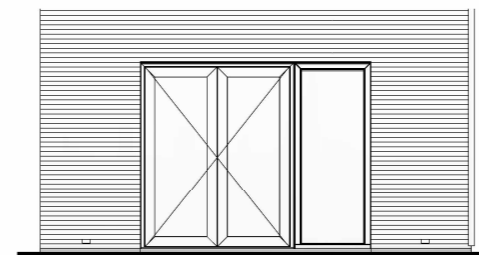
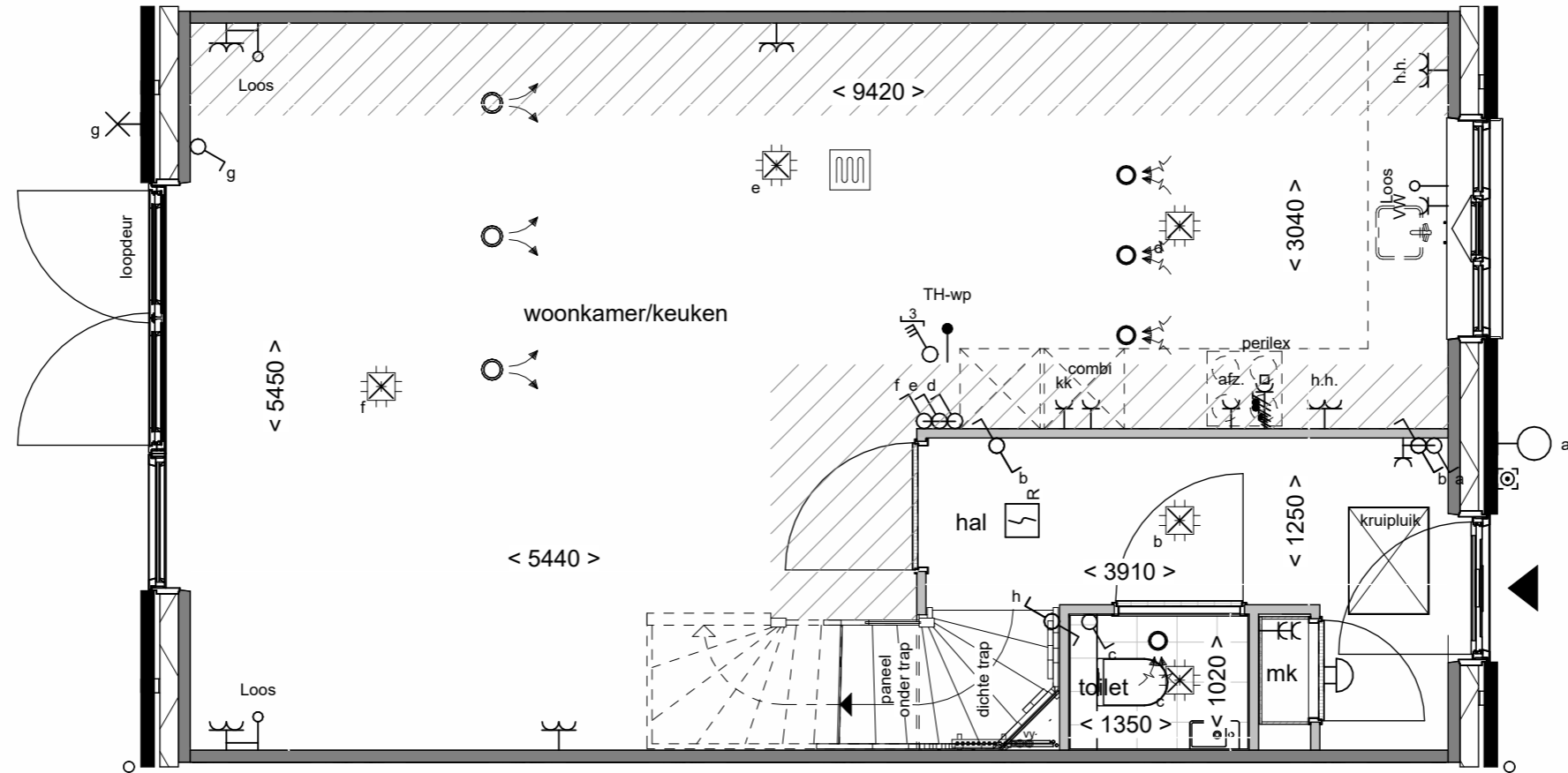

Achtergevel schaal 1:100



STEENBRUGGE
DEVENTER



Openslaande
deuren 1 zijlicht

Tekening:

Woningtype: C57

Bouwnummer: -

Optienummer: 1.A.X.58

Bladformaat: A3

Schaal: 1:50 / 1:100

Datum: 26-11-2024

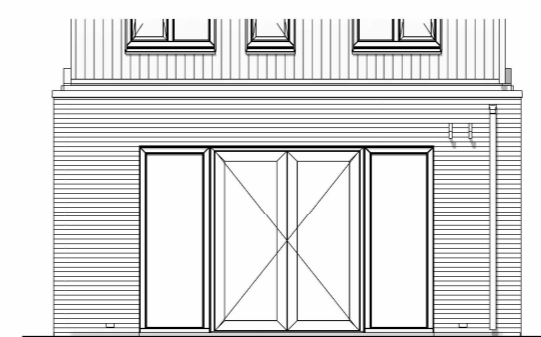
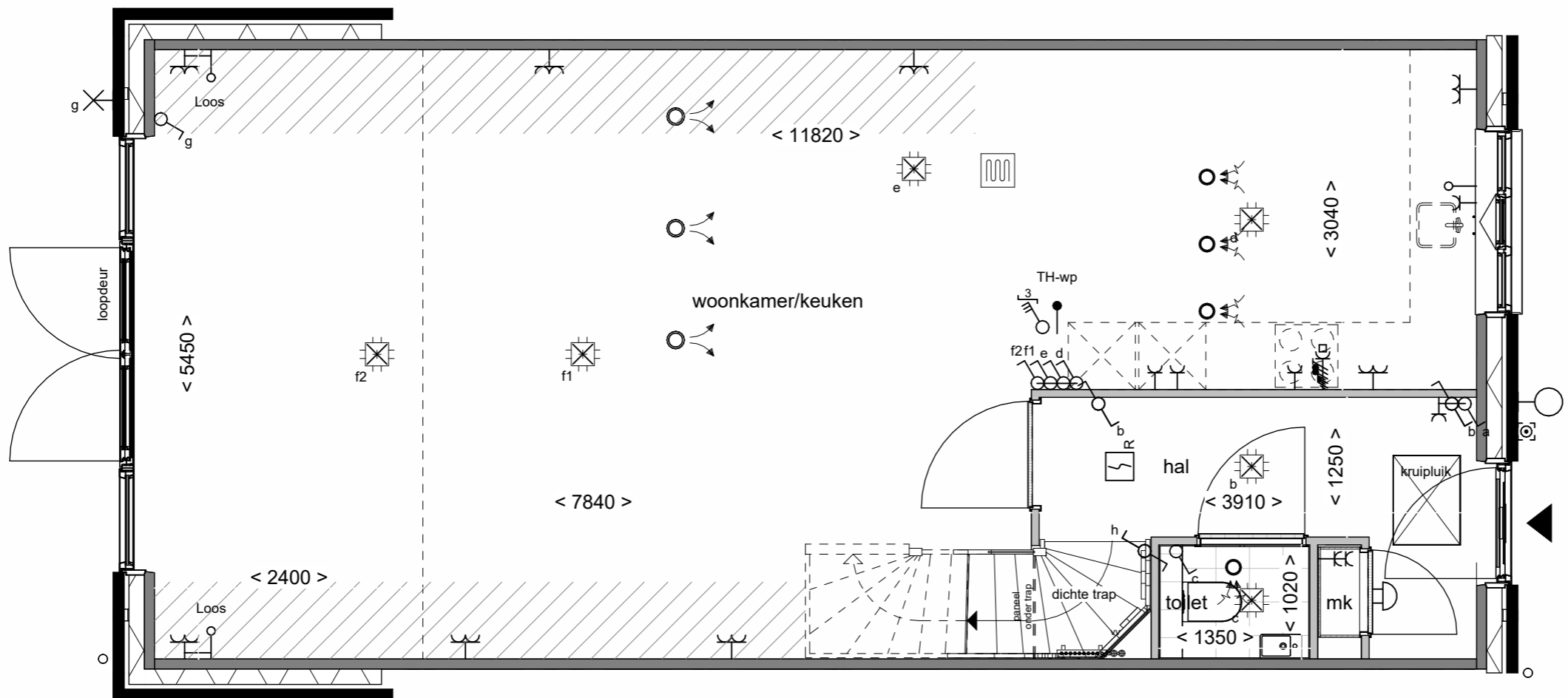

Achtergevel schaal 1:100



STEENBRUGGE
DEVENTER



Openstaande
deuren 2 zijlichten

Tekening: Openstaande deuren 2 zijlichten

Woningtype: C57

Bouwnummer: -

Optienummer: 1.A.X.62

Bladformaat: A3

Schaal: 1:50 / 1:100

Datum: 26-11-2024

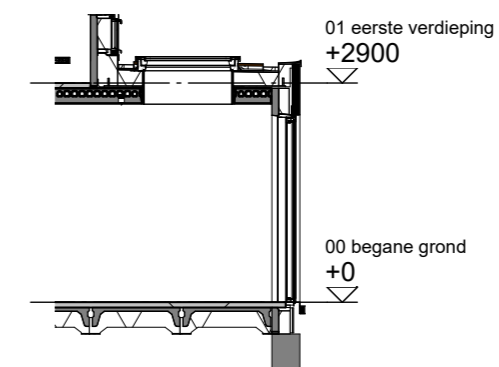
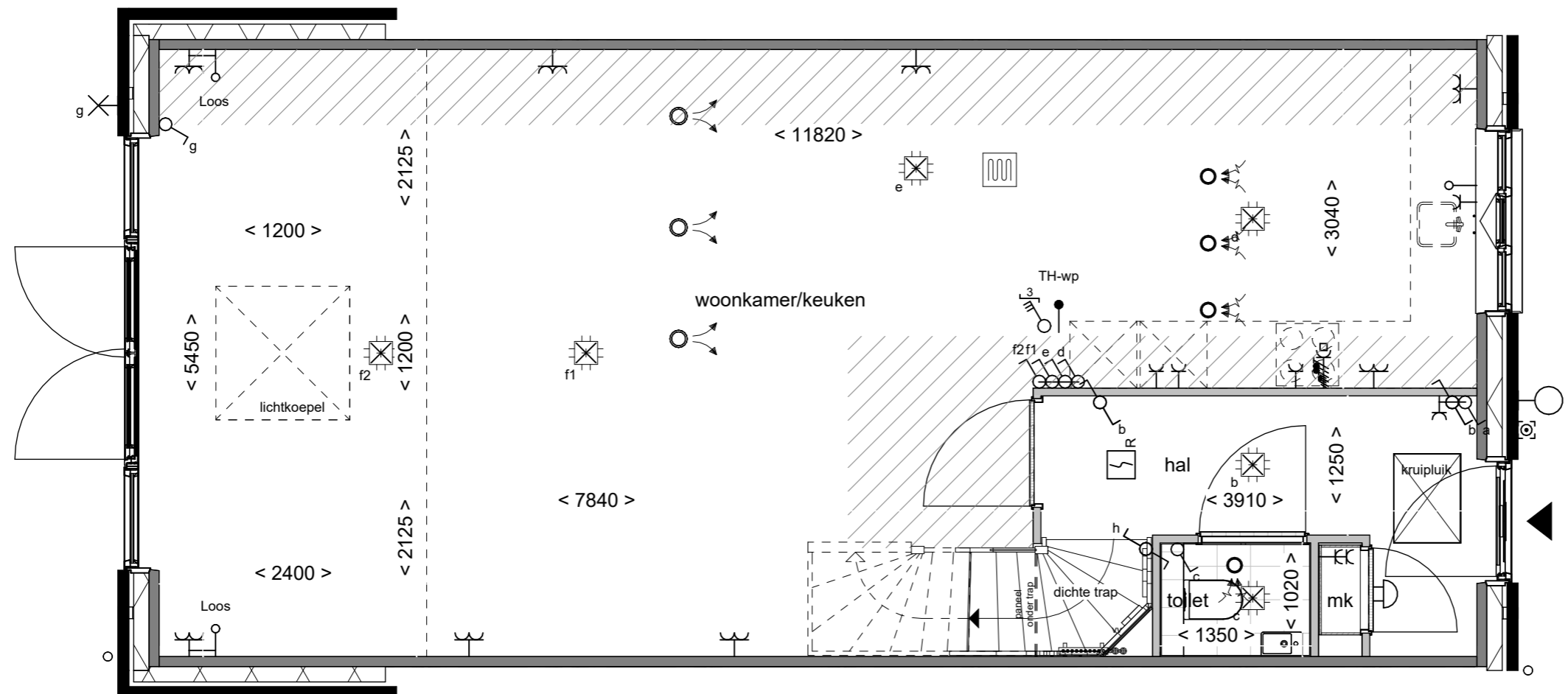

Doorsnede schaal 1:100



STEENBRUGGE
DEVENTER



Lichtkoepel in
uitbouw 240cm

Tekening:

Woningtype: C57

Bouwnummer: -

Optienummer: 1.B.X.10

Bladformaat: A3

Schaal: 1:50 / 1:100

Datum: 26-11-2024

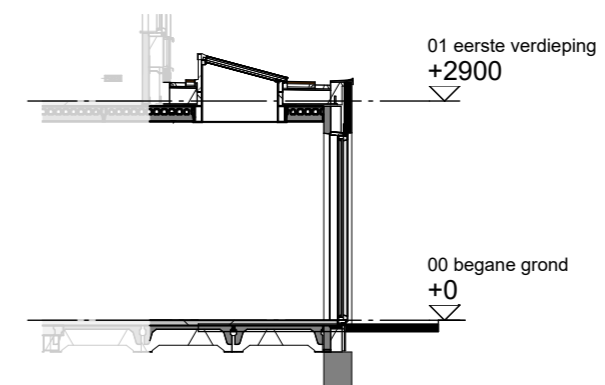
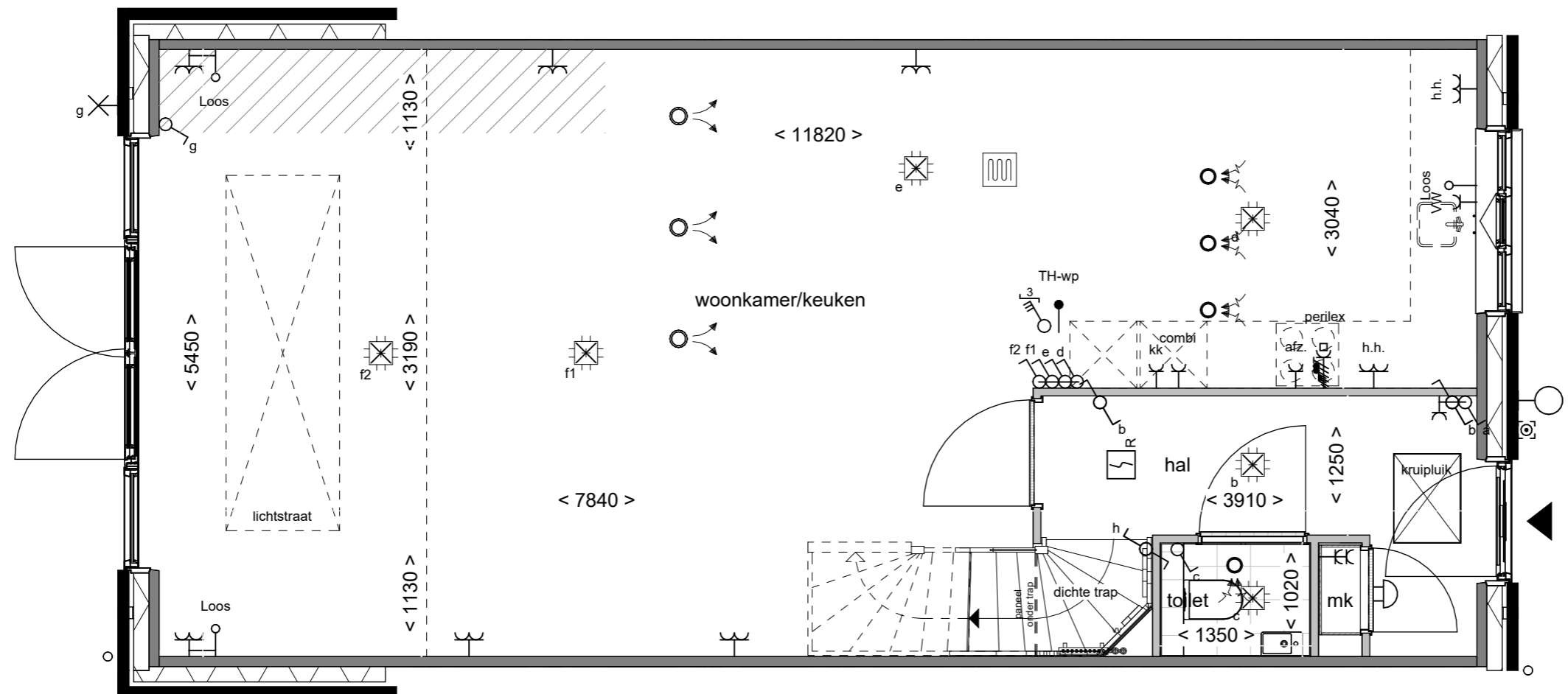

Doorsnede schaal 1:100



STEENBRUGGE
DEVENTER



Lichtstraat in
uitbouw 240cm

Tekening:

Woningtype: C57

Bouwnummer: -

Optienummer: 1.B.X.14

Bladformaat: A3

Schaal: 1:50 / 1:100

Datum: 26-11-2024

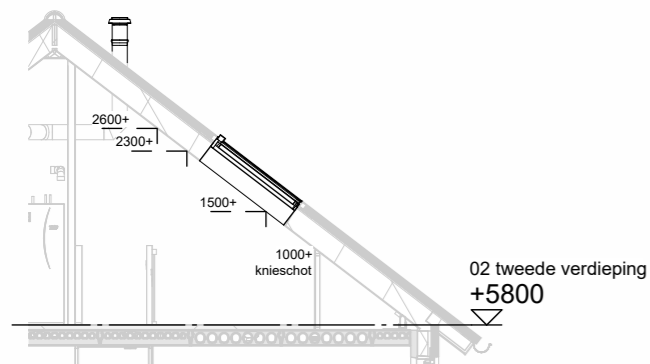
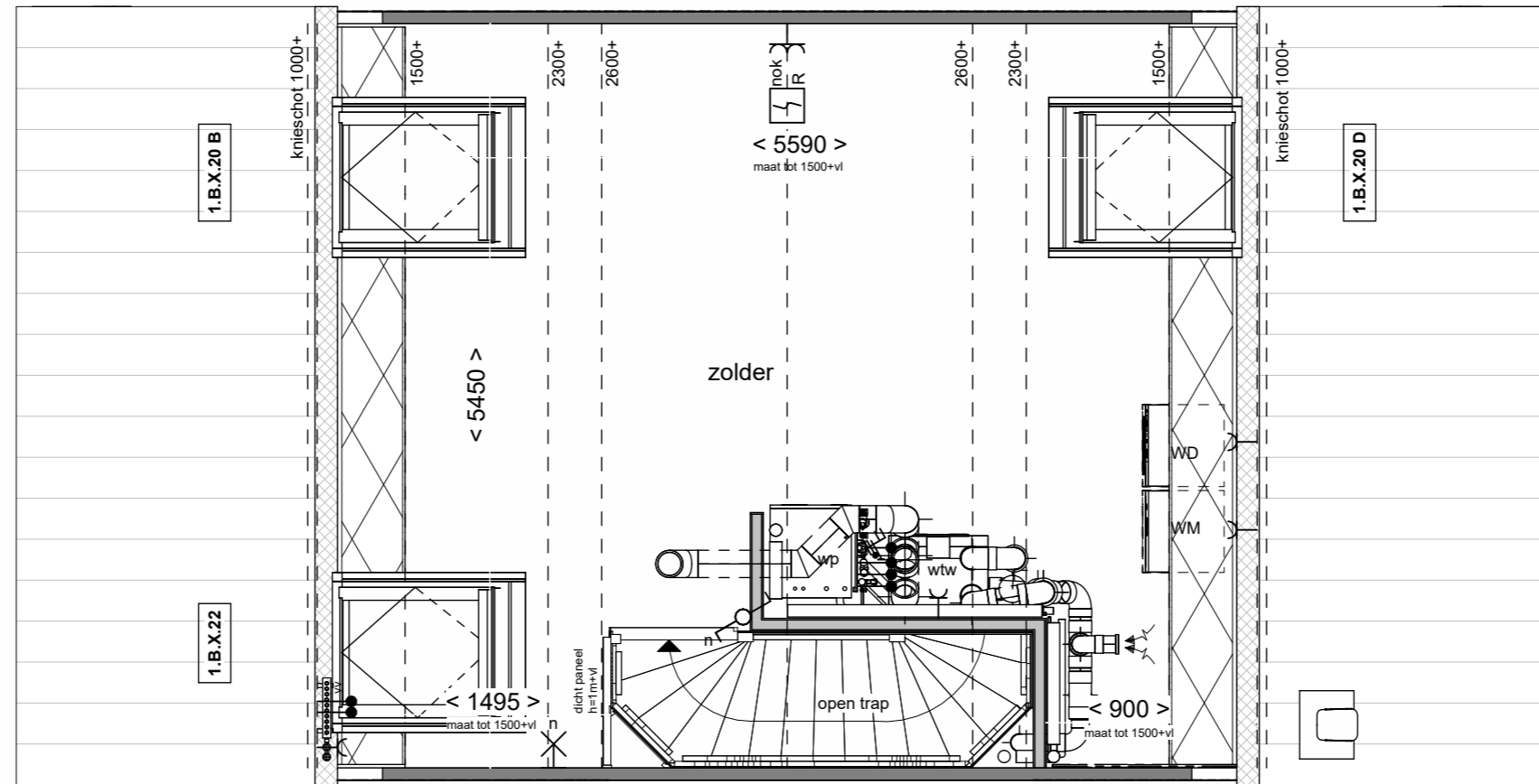

Doorsnede schaal 1:100

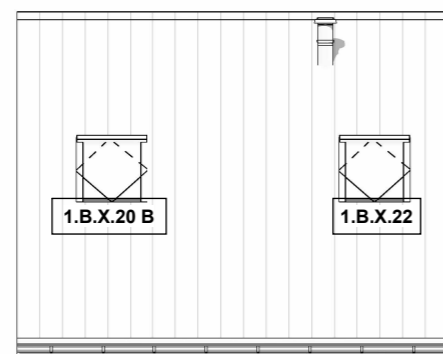

Achtergevel schaal 1:100

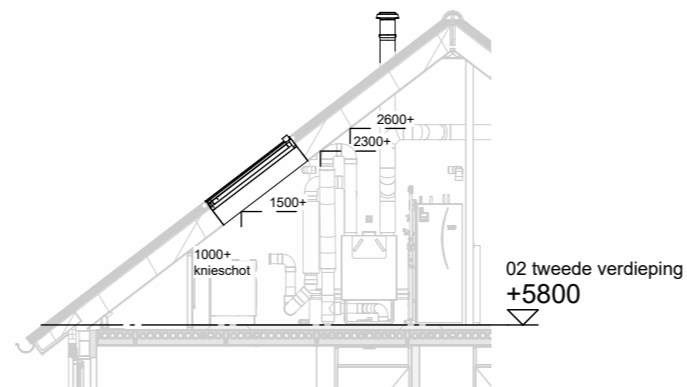

Doorsnede schaal 1:100

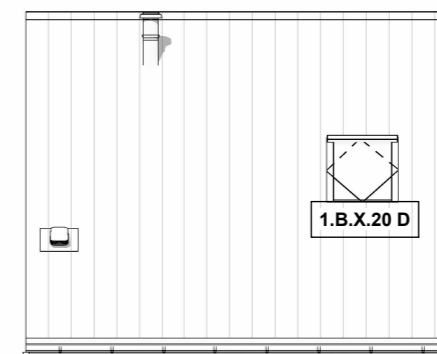

Voorgevel schaal 1:100



STEENBRUGGE
DEVENTER



Dakramen voor-
en achtergevel

Tekening:

Woningtype: C57

Bouwnummer: -

Optienummer: 1.B.X.20 / 1.B.X.22

Bladformaat: A3

Schaal: 1:50 / 1:100

Datum: 26-11-2024

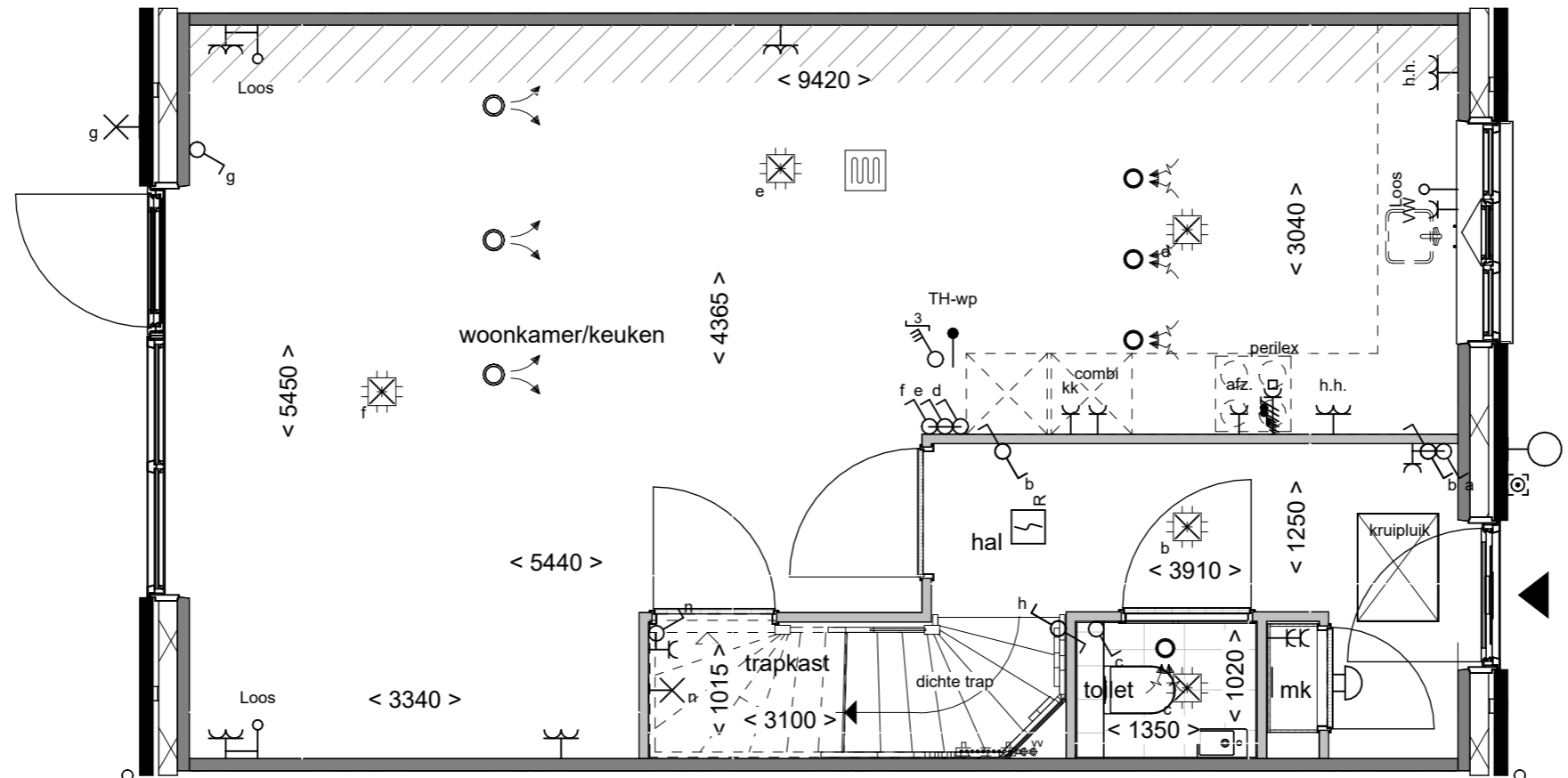

STEENBRUGGE
DEVENTER



Trapkast

Tekening:

Woningtype: C57

Bouwnummer: -

Optienummer: 1.C.C.10

Bladformaat: A3

Schaal: 1:50

Datum: 26-11-2024

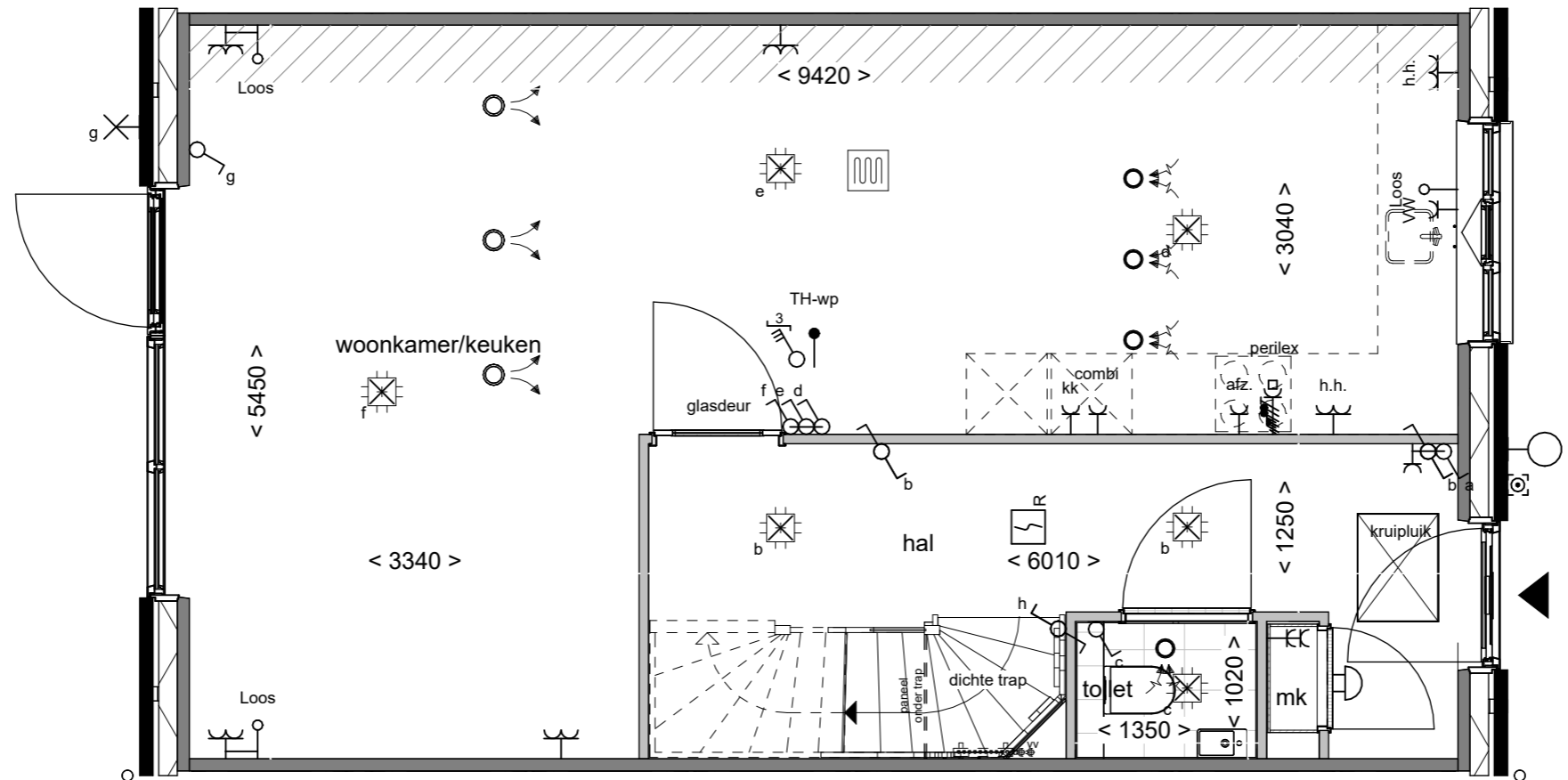

STEENBRUGGE
DEVENTER



VAN WIJNEN
Vergroten hal met
glasdeur

Tekening:

Woningtype: C57

Bouwnummer: -

Optienummer: 1.C.C.12

Bladformaat: A3

Schaal: 1:50

Datum: 26-11-2024

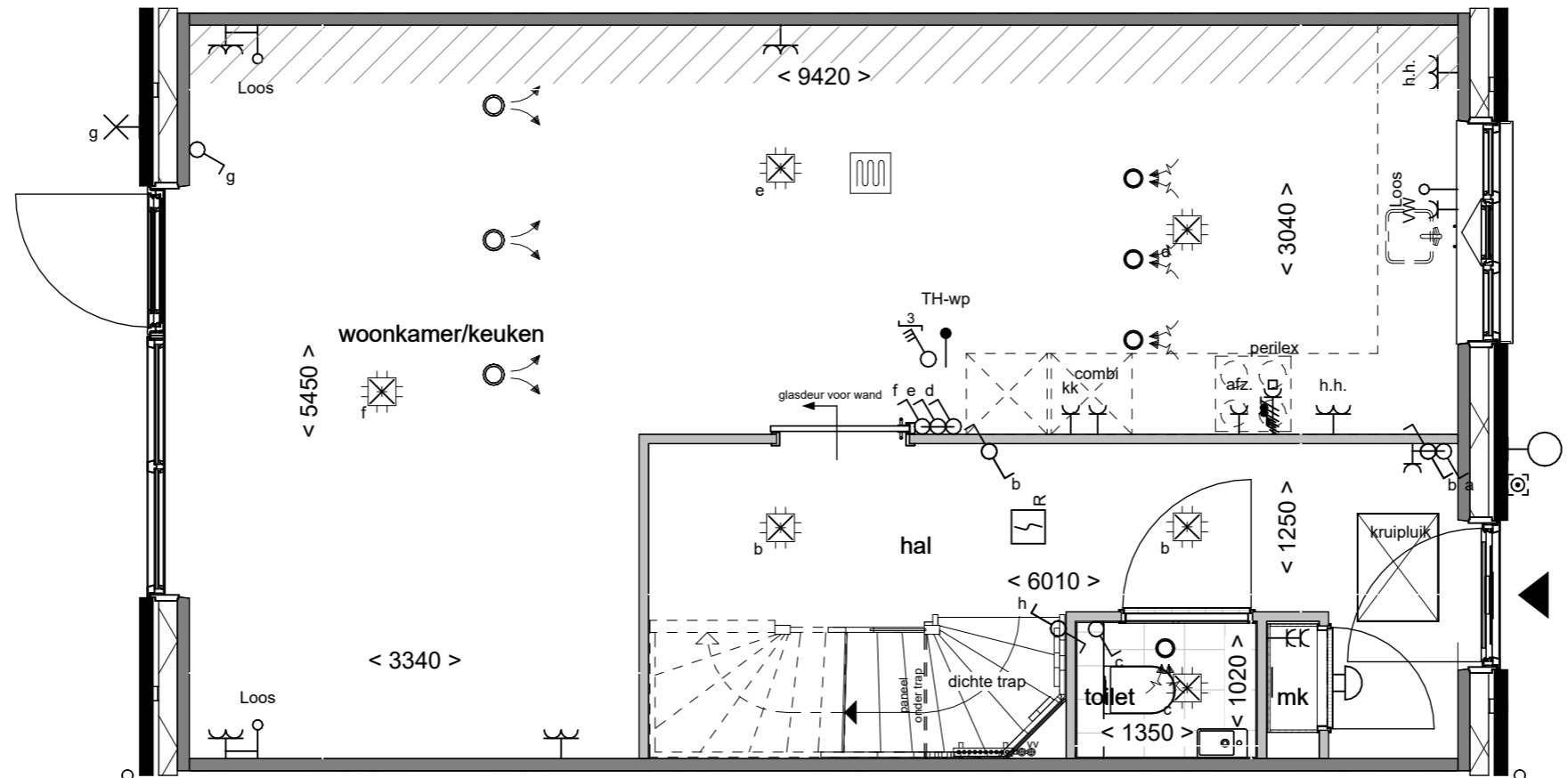

STEENBRUGGE
DEVENTER



Schuifdeur voor de
wand

Tekening:

Woningtype: C57

Bouwnummer: -

Optienummer: 1.C.C.12 - 2.L.0.24

Bladformaat: A3

Schaal: 1:50

Datum: 26-11-2024

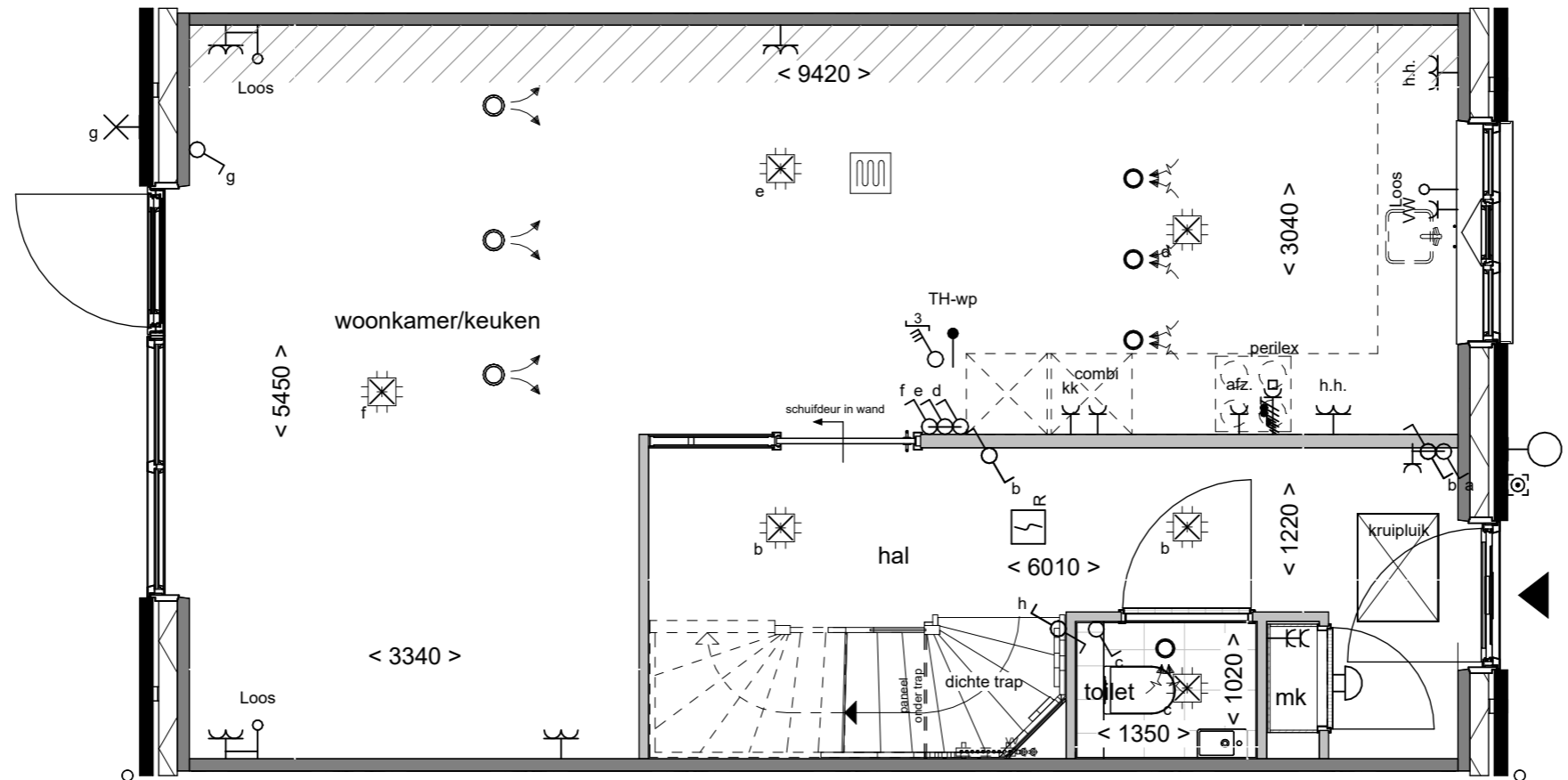

STEENBRUGGE
DEVENTER



Tekening: **Schuifdeur in de wand**

Woningtype: **C57**

Bouwnummer: **-**

Optienummer: **1.C.C.12 - 2.L.0.26**

Bladformaat: **A3**

Schaal: **1:50**

Datum: **26-11-2024**

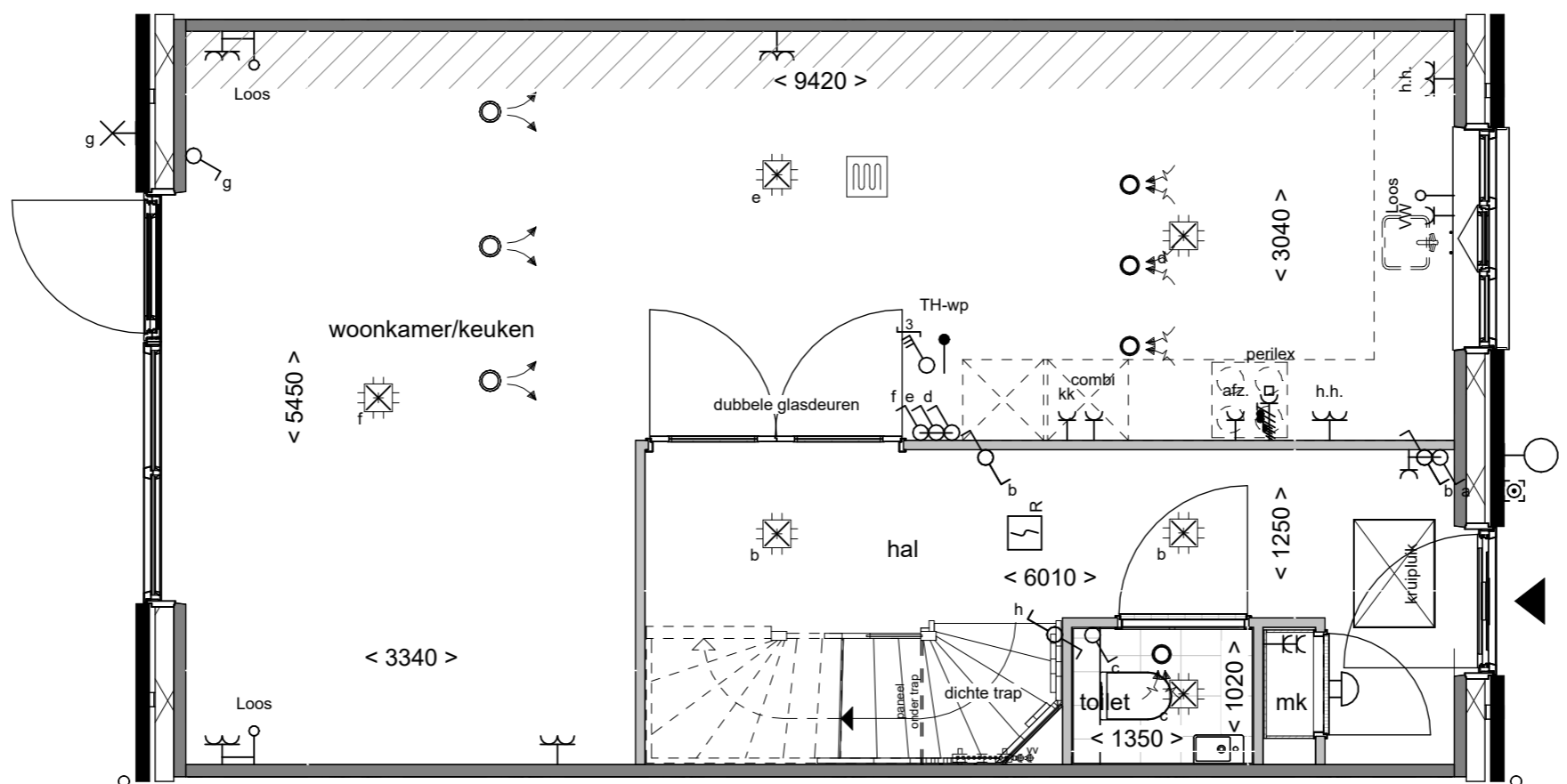

STEENBRUGGE
DEVENTER



VAN WIJNEN

Tekening: Vergroten hal met
2 glasdeuren

Woningtype: C57

Bouwnummer: -

Optienummer: 1.C.C.14

Bladformaat: A3

Schaal: 1:50

Datum: 26-11-2024

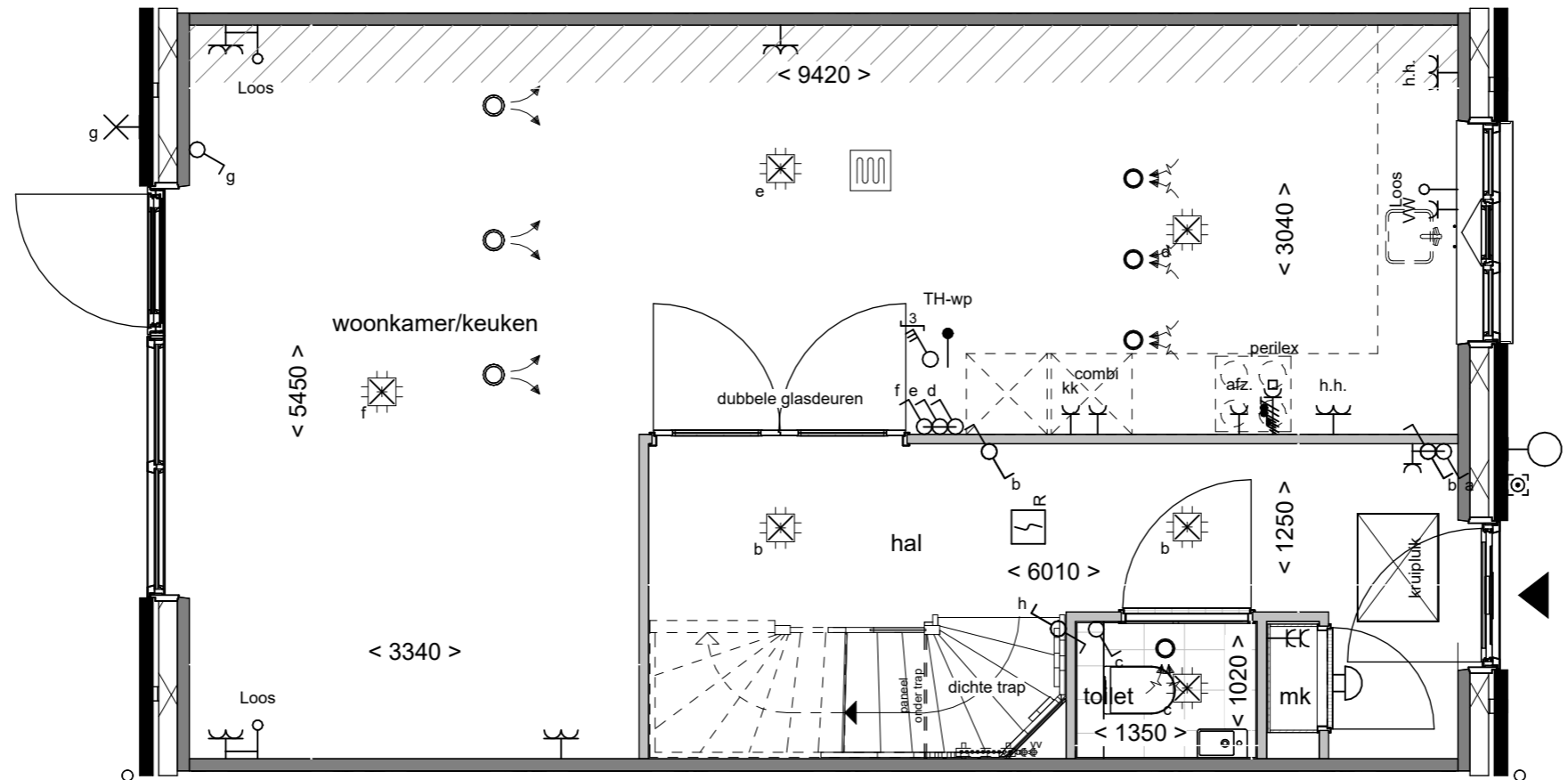

STEENBRUGGE
DEVENTER



Tekening: Vergroten hal met 2 glasdeuren
 Woningtype: C57
 Bouwnummer: -
 Optienummer: 1.C.C.14
 Bladformaat: A3
 Schaal: 1:50
 Datum: 26-11-2024

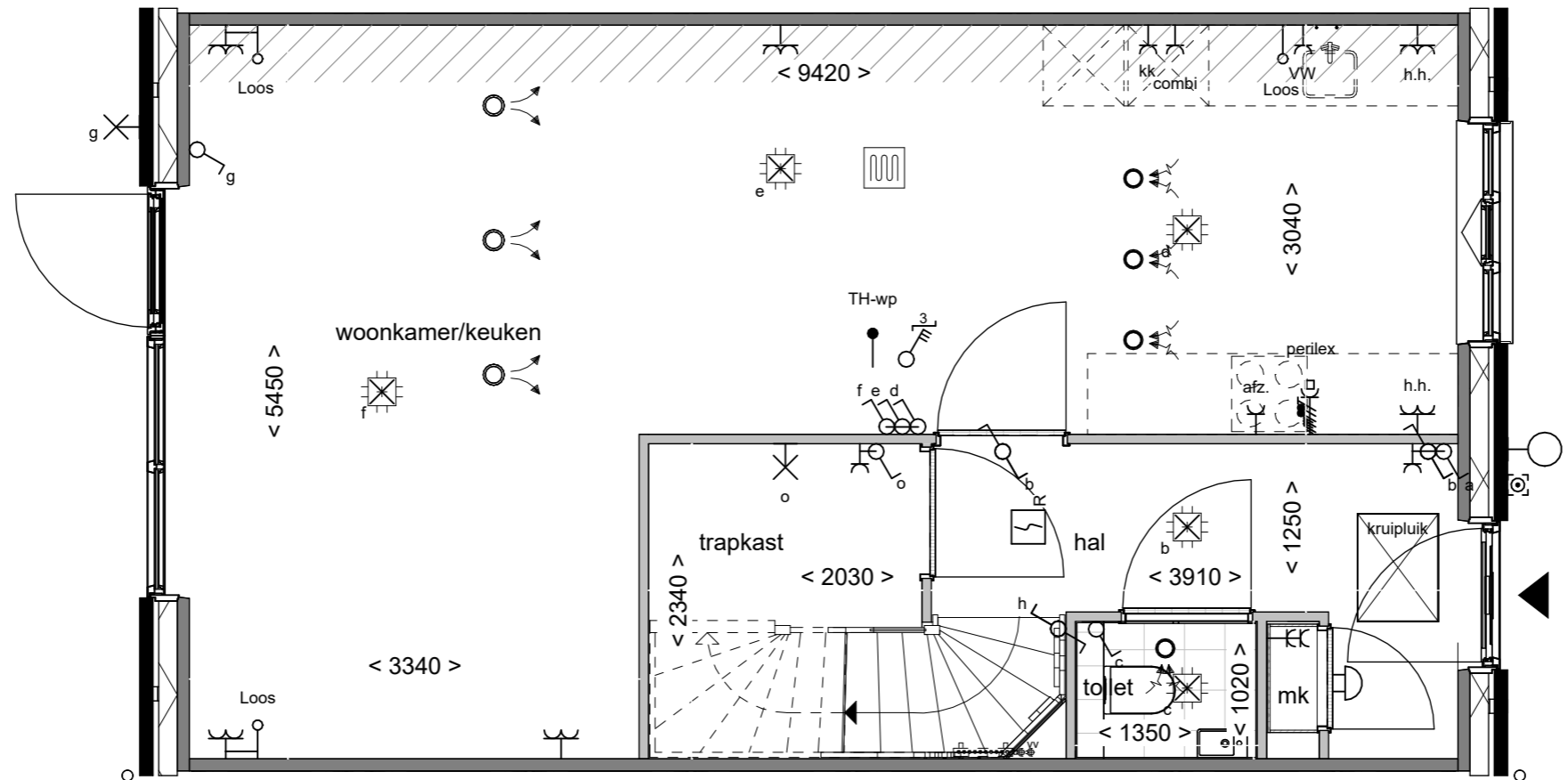

STEENBRUGGE
DEVENTER



Vergroten trapkast

Tekening:	_____
Woningtype:	C57
Bouwnummer:	-
Optienummer:	1.C.C.16
Bladformaat:	A3
Schaal:	1:50
Datum:	26-11-2024

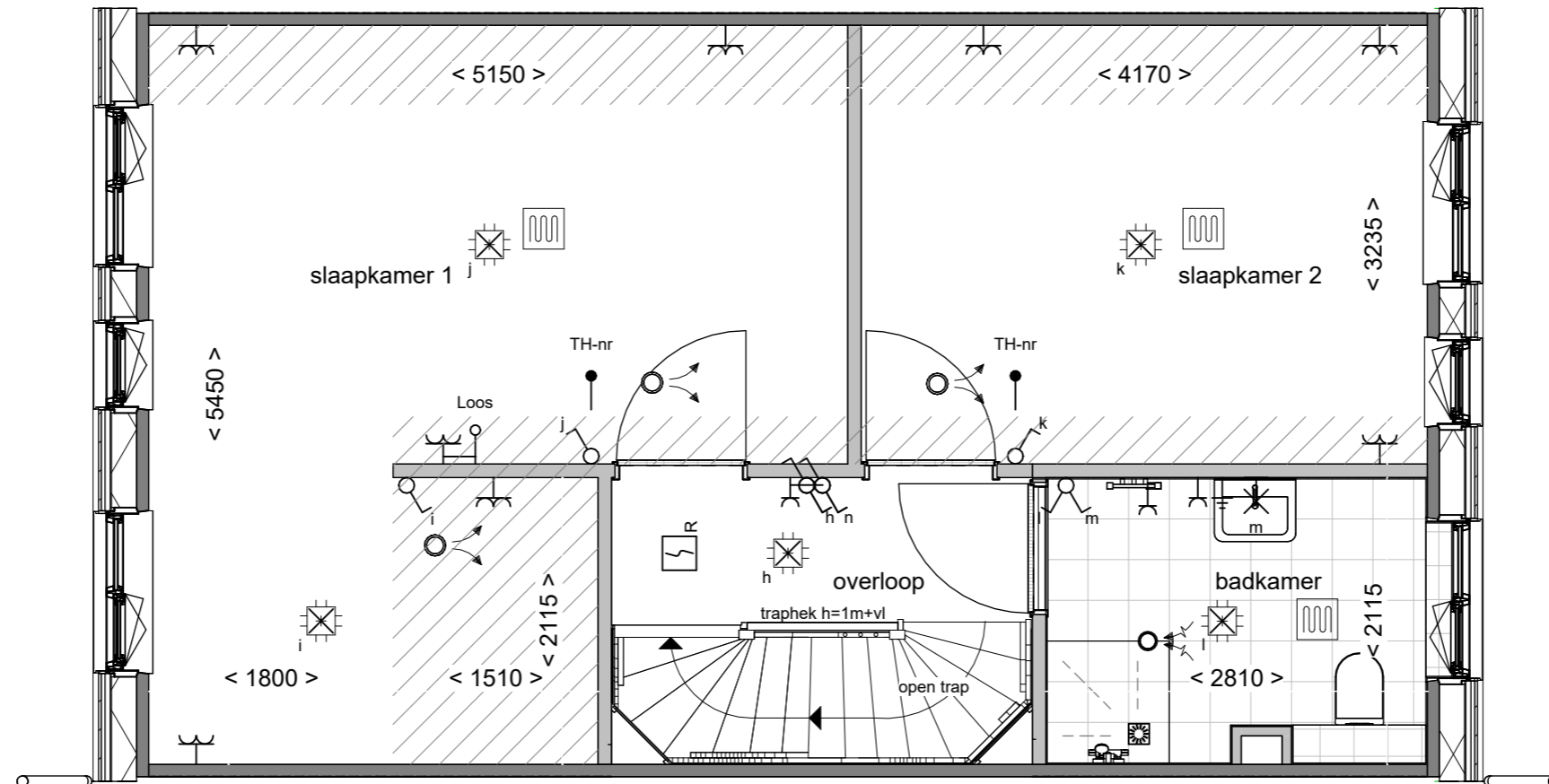

STEENBRUGGE
DEVENTER



Tekening: Slpk 1 en 3 samen
voegen incl. wand

Woningtype: C57

Bouwnummer: -

Optienummer: 1.C.C.30

Bladformaat: A3

Schaal: 1:50

Datum: 26-11-2024

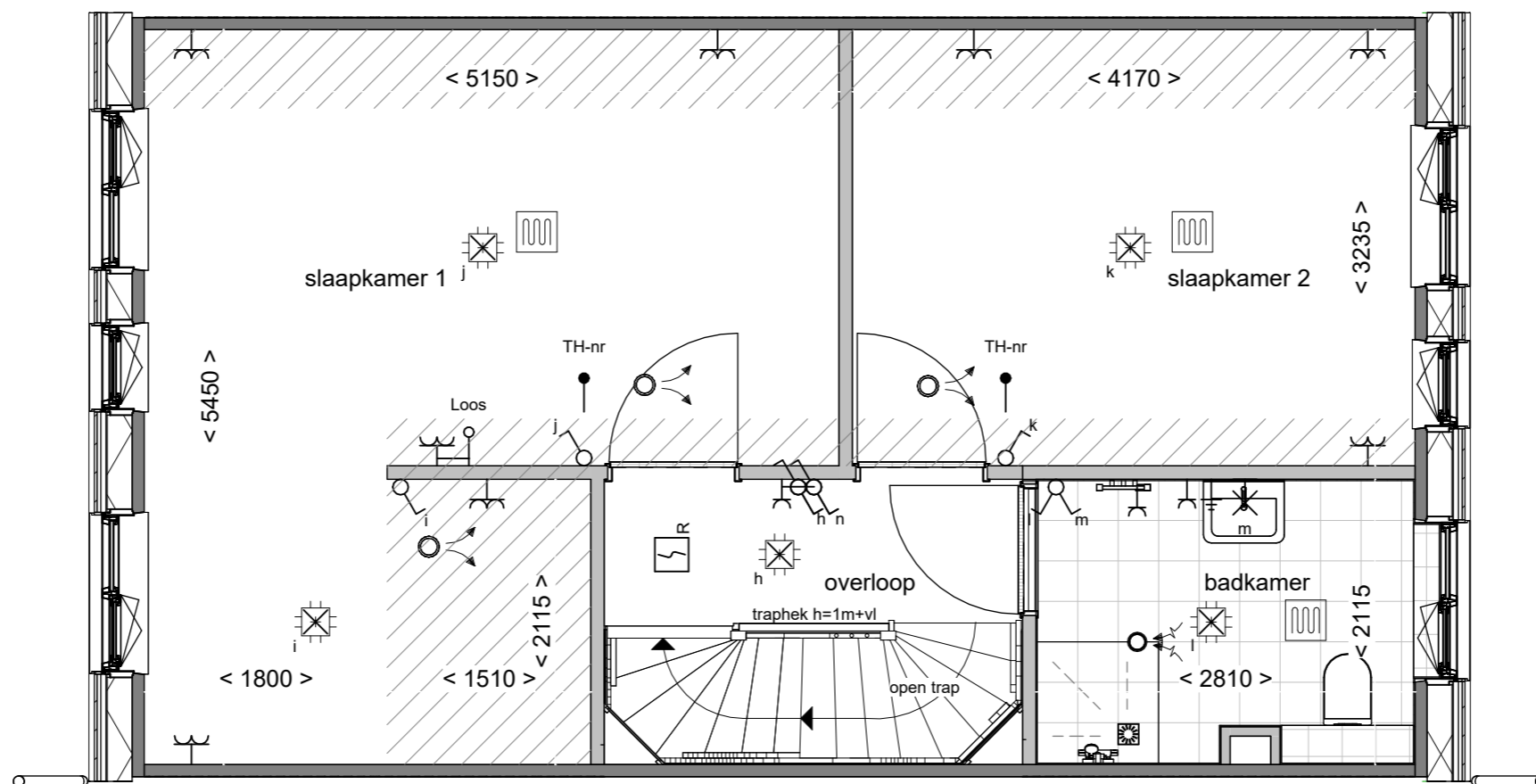

STEENBRUGGE
DEVENTER



Tekening: Slpk 1 en 3 samen
voegen incl. wand

Woningtype: C57

Bouwnummer: -

Optienummer: 1.C.C.30

Bladformaat: A3

Schaal: 1:50

Datum: 26-11-2024

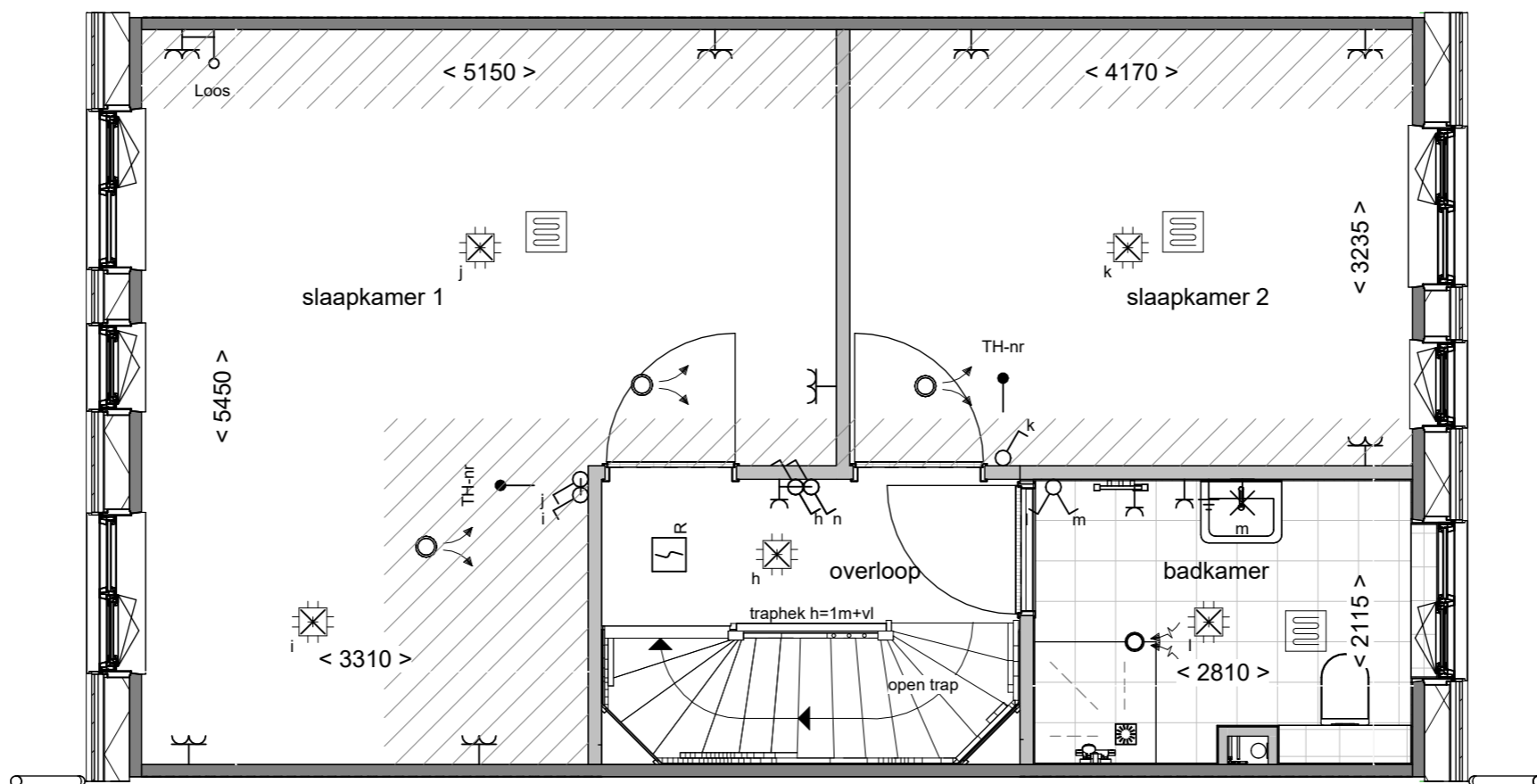

STEENBRUGGE
DEVENTER



VAN WIJNEN
Samenvoegen
slaapk. achterzijde

Tekening: Samenvoegen
slaapk. achterzijde

Woningtype: C57

Bouwnummer: -

Optienummer: 1.C.C.32

Bladformaat: A3

Schaal: 1:50

Datum: 26-11-2024

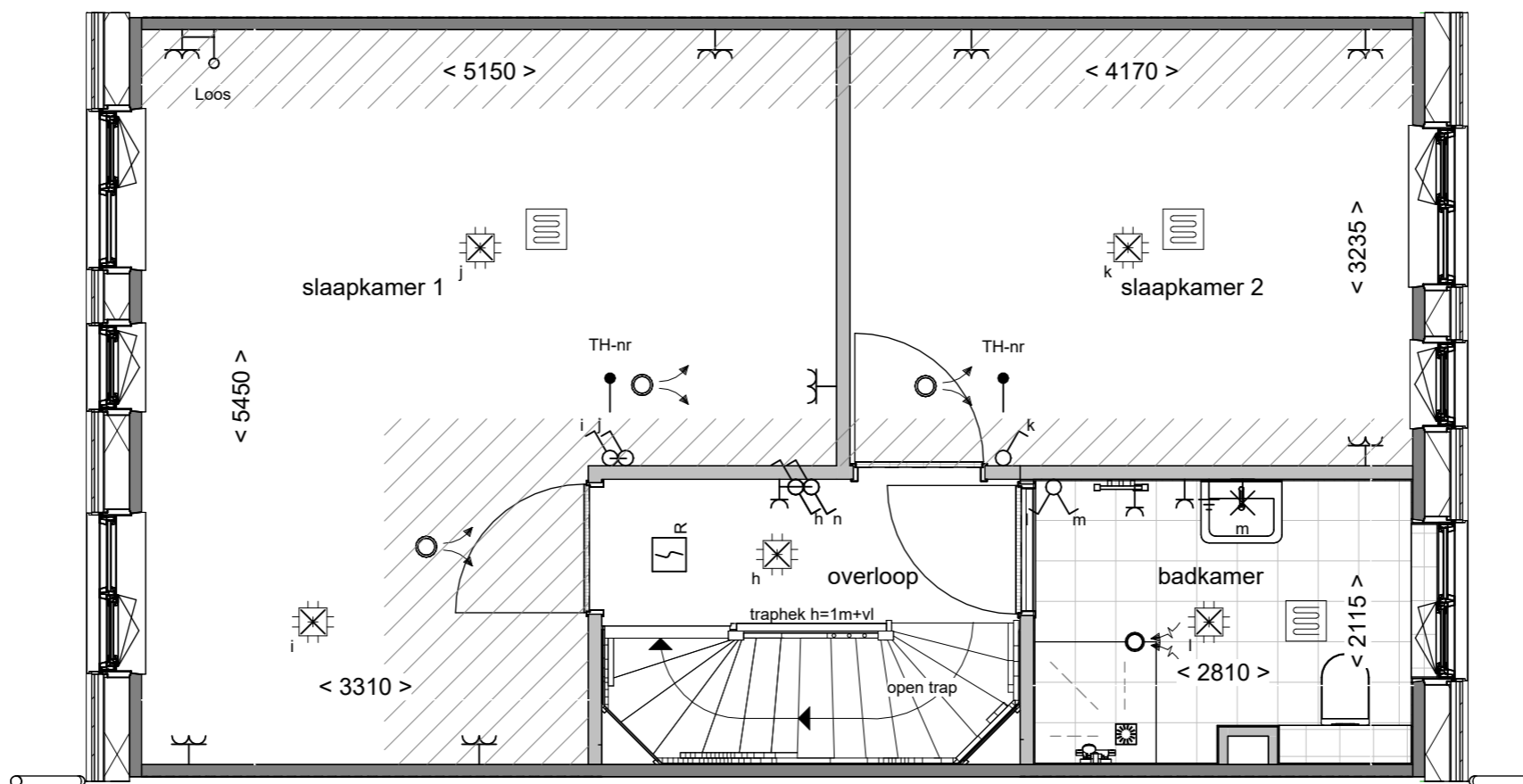

STEENBRUGGE
DEVENTER



Tekening: Samenvoegen
slaapk. achterzijde

Woningtype: C57

Bouwnummer: -

Optienummer: 1.C.C.33

Bladformaat: A3

Schaal: 1:50

Datum: 26-11-2024

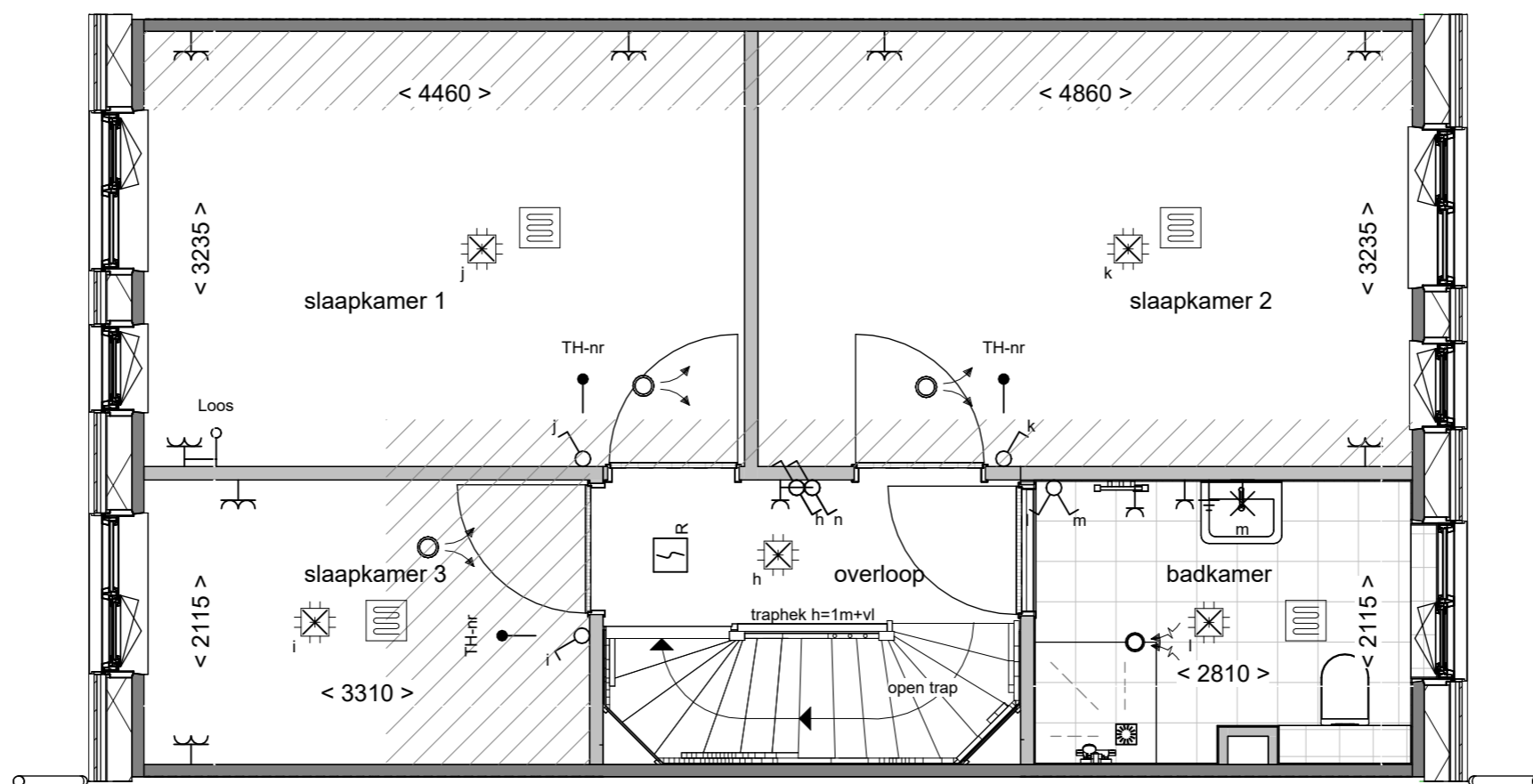

STEENBRUGGE
DEVENTER



Vergroten
slaapkamer 2

Tekening:

Woningtype: C57

Bouwnummer: -

Optienummer: 1.C.C.34

Bladformaat: A3

Schaal: 1:50

Datum: 26-11-2024

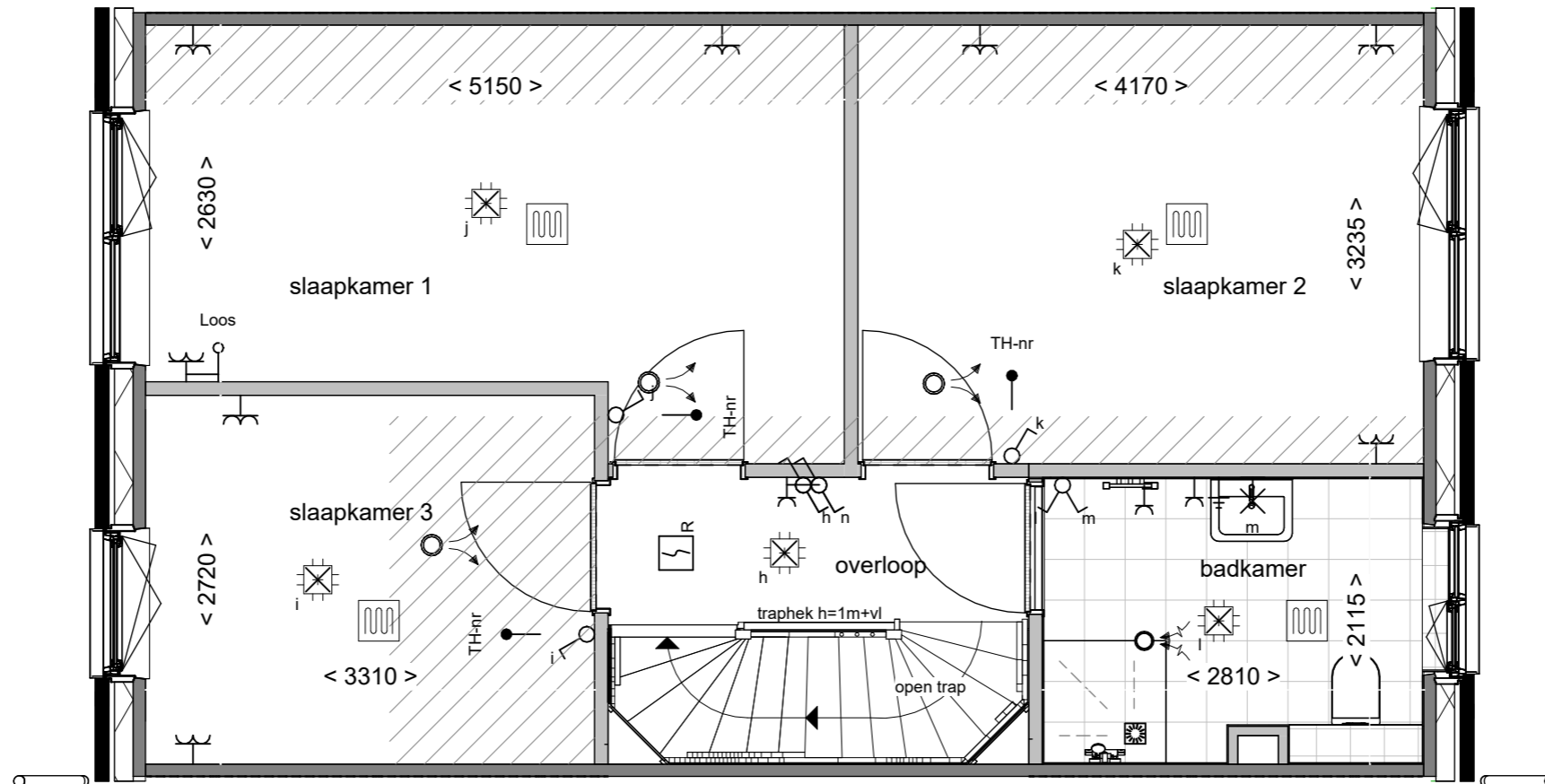

STEENBRUGGE
DEVENTER



Vergroten
slaapkamer 3

Tekening:

Woningtype: C57

Bouwnummer: -

Optienummer: 1.C.C.36

Bladformaat: A3

Schaal: 1:50

Datum: 26-11-2024

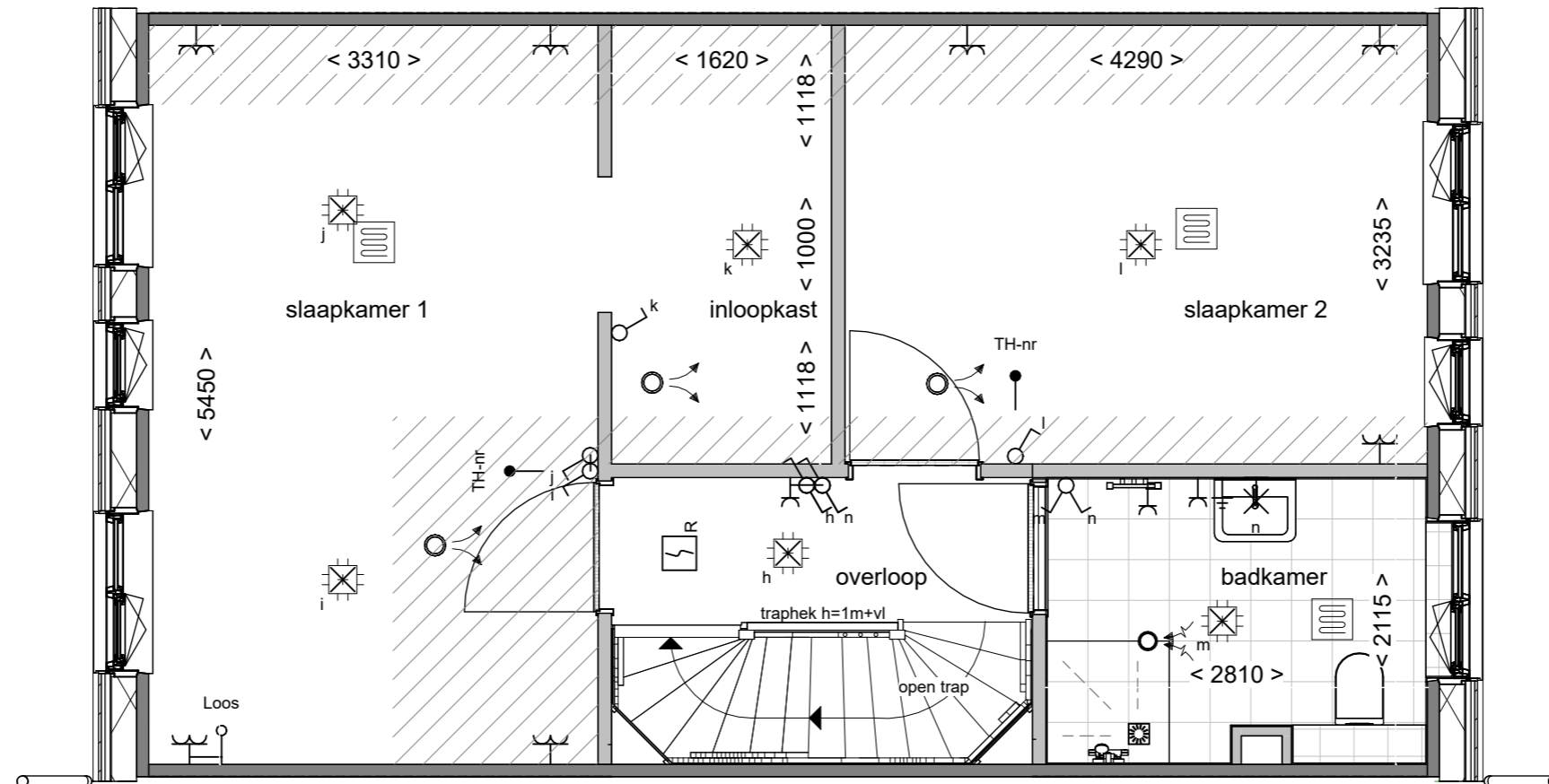

STEENBRUGGE
DEVENTER



Tekening: **Inloopkast in slaapk. achterzijde**

Woningtype: **C57**

Bouwnummer: **-**

Optienummer: **1.C.C.38**

Bladformaat: **A3**

Schaal: **1:50**

Datum: **26-11-2024**

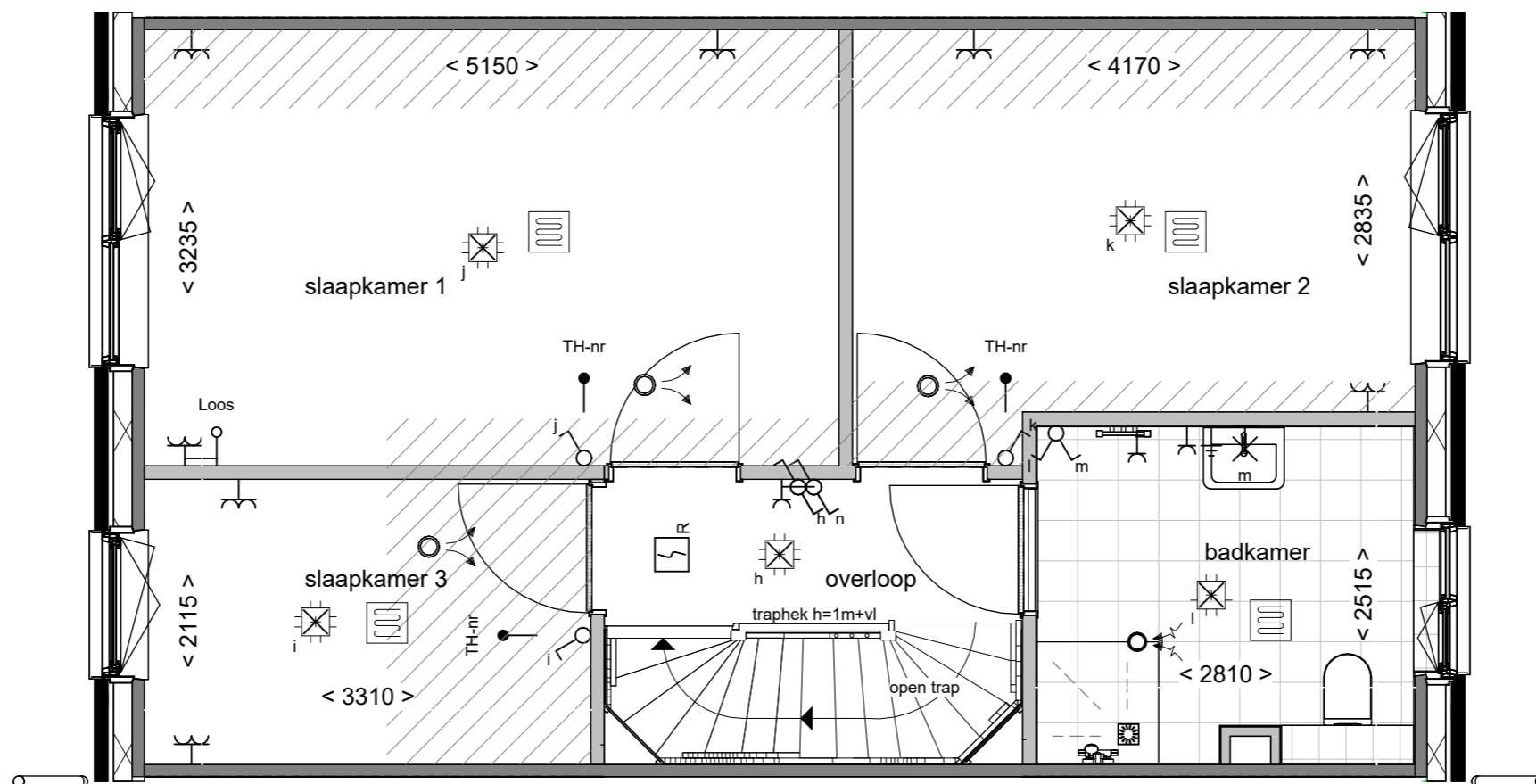

STEENBRUGGE
DEVENTER



VAN WIJNEN
Vergroten badk.
met ca. 40cm

Tekening: _____

Woningtype: C57 _____

Bouwnummer: - _____

Optienummer: 1.C.C.40 _____

Bladformaat: A3 _____

Schaal: 1:50 _____

Datum: 26-11-2024 _____

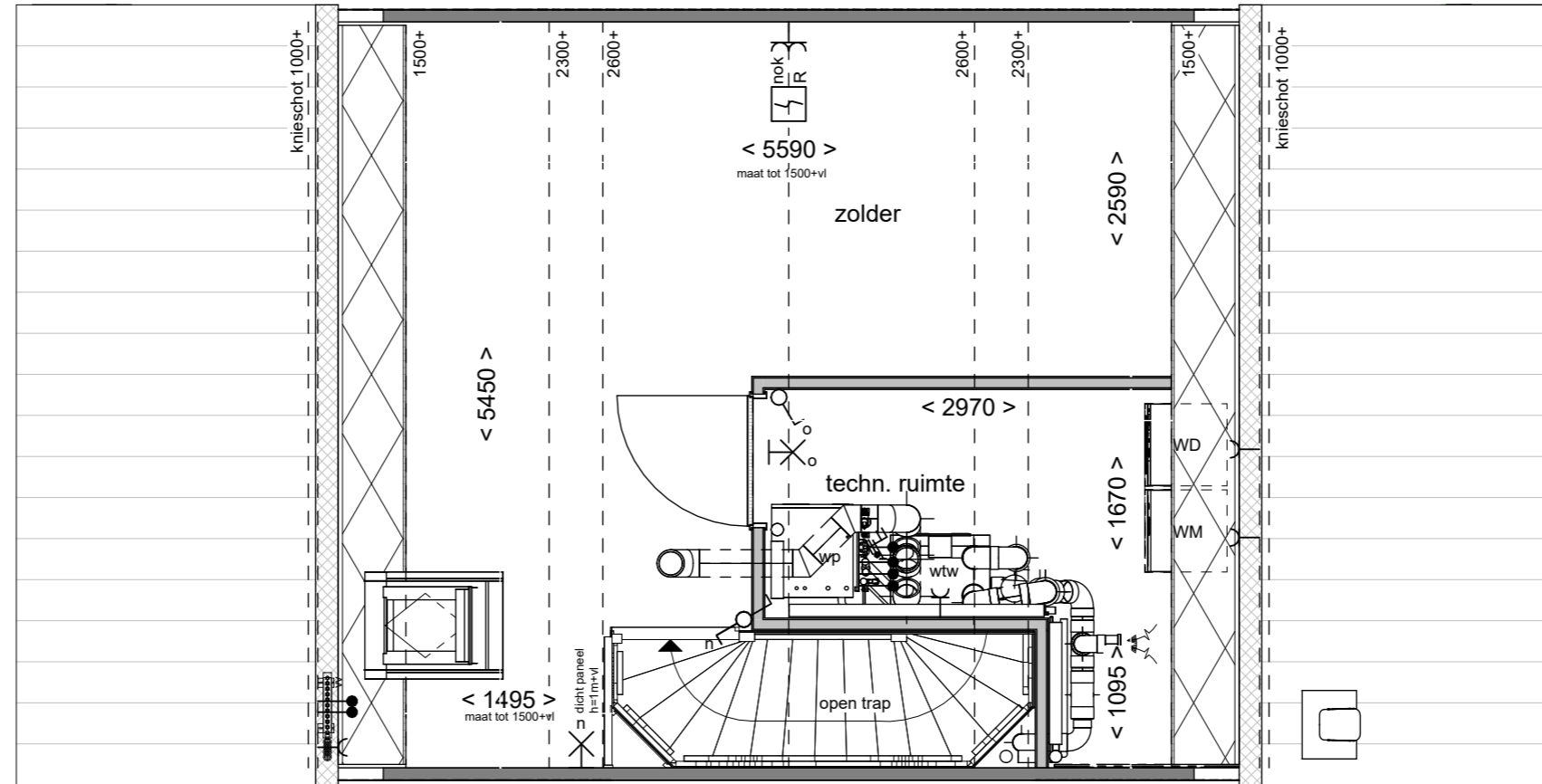

STEENBRUGGE
DEVENTER



Tekening: **Indeling met
techniekrumte**

Woningtype: **C57**

Bouwnummer: **-**

Optienummer: **1.C.C.70**

Bladformaat: **A3**

Schaal: **1:50**

Datum: **26-11-2024**

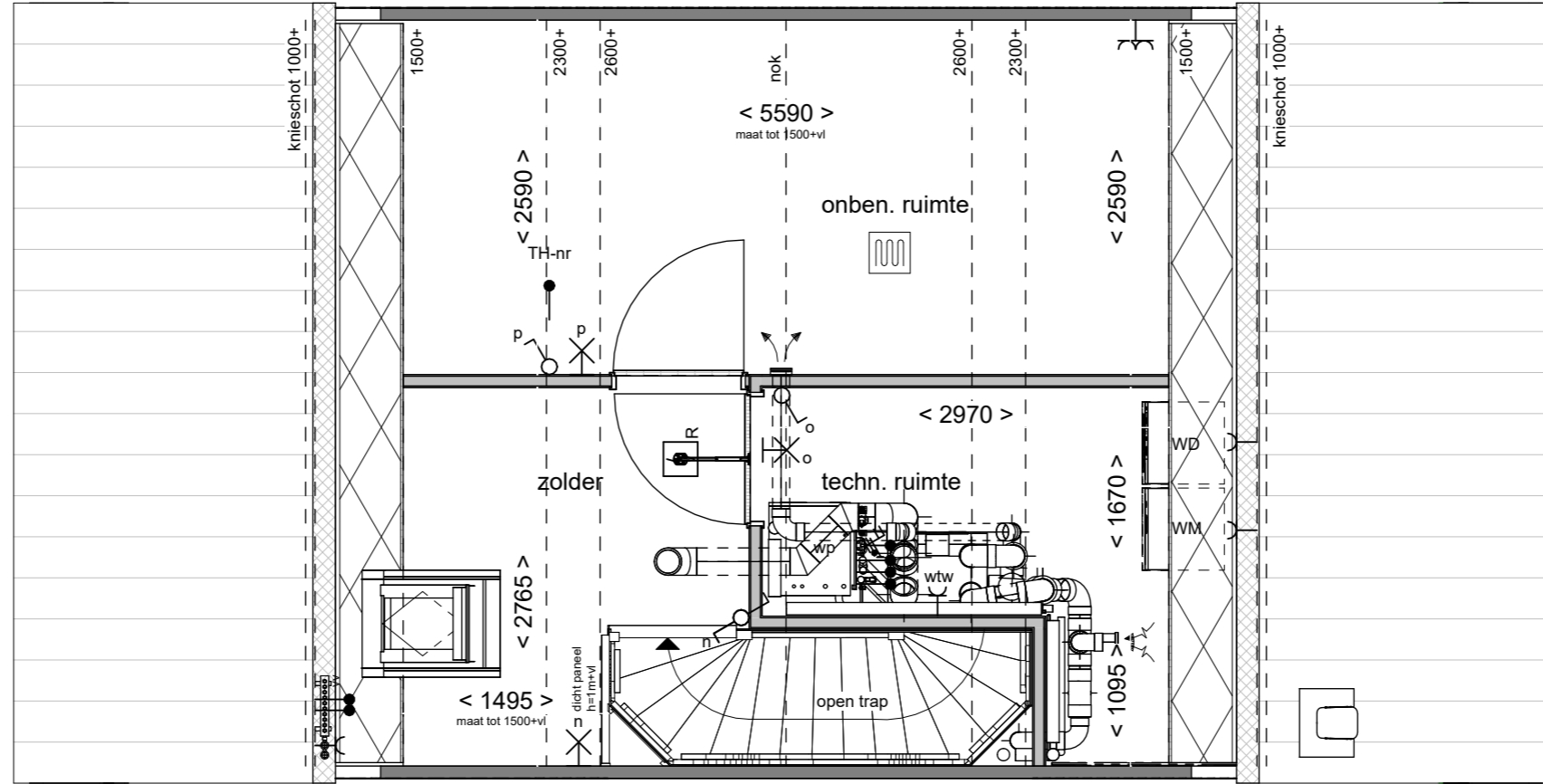

STEENBRUGGE
DEVENTER



Tekening: Indeling met techn.
en onben. ruimte

Woningtype: C57

Bouwnummer: -

Optienummer: 1.C.C.72

Bladformaat: A3

Schaal: 1:50

Datum: 26-11-2024

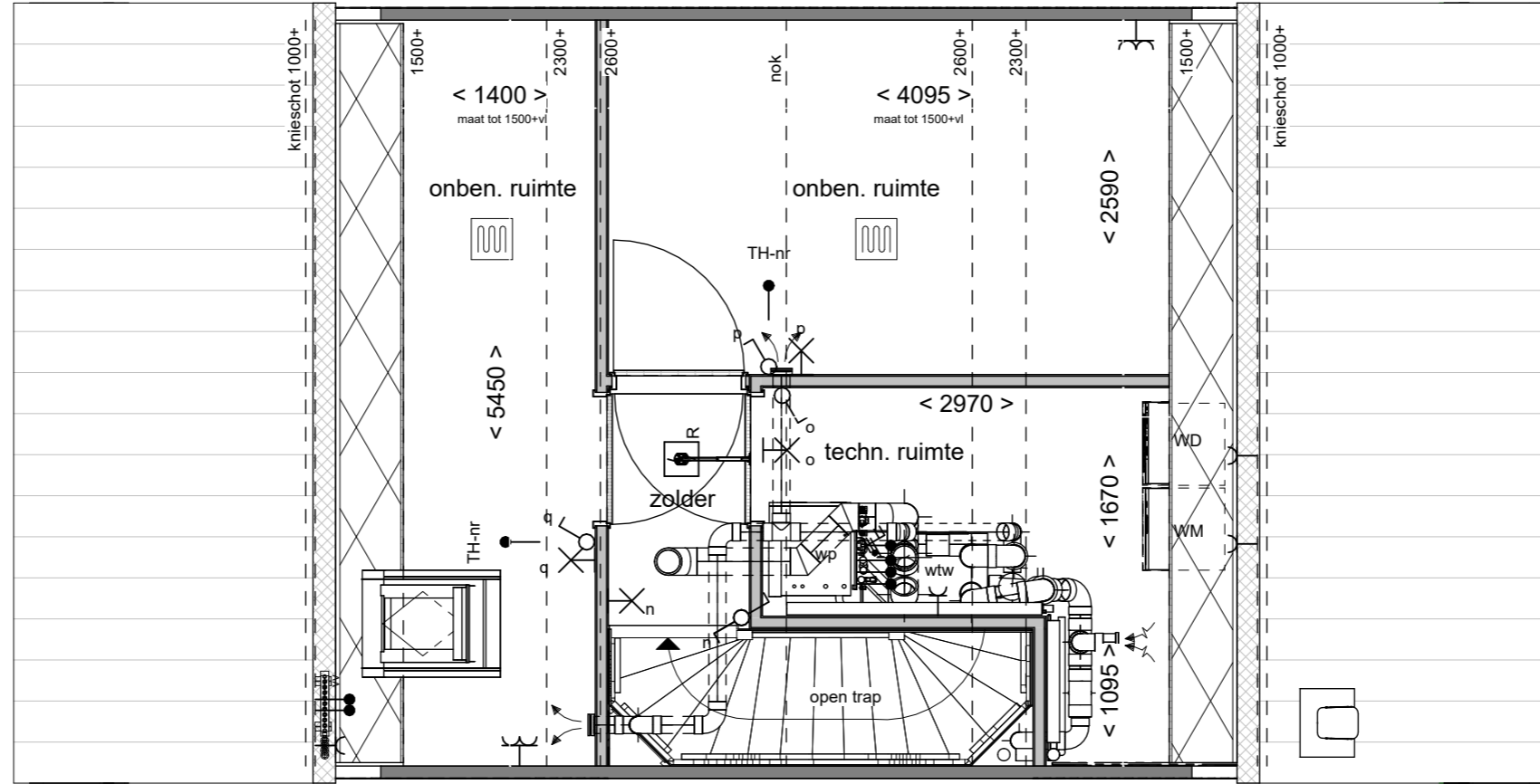

STEENBRUGGE
DEVENTER



Tekening: Indeling techn.- en
2 onb. ruimtes

Woningtype: C57

Bouwnummer: -

Optienummer: 1.C.C.76

Bladformaat: A3

Schaal: 1:50

Datum: 26-11-2024

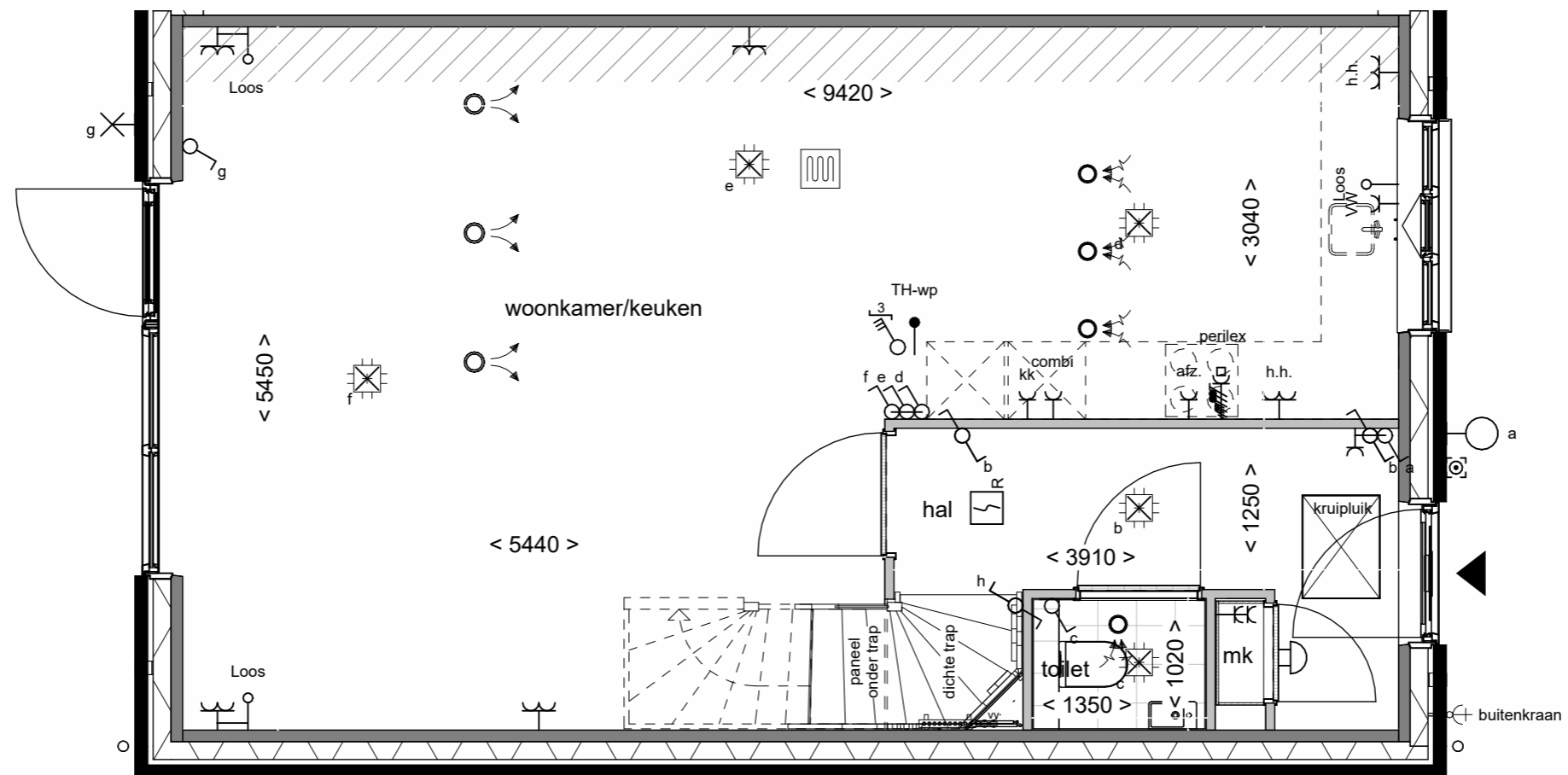

Voorgevel schaal 1:100



STEENBRUGGE
DEVENTER



vorstvrije
buitenkraan voor

Tekening: _____

Woningtype: C57 _____

Bouwnummer: - _____

Optienummer: 2.K.0.40 _____

Bladformaat: A3 _____

Schaal: 1:50 / 1:100 _____

Datum: 26-11-2024 _____

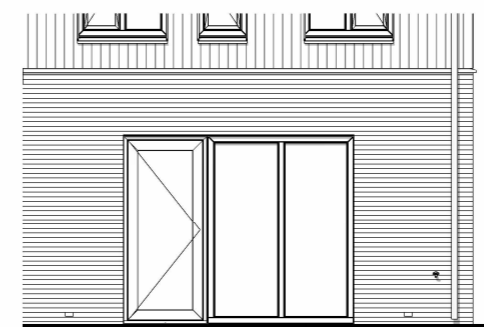
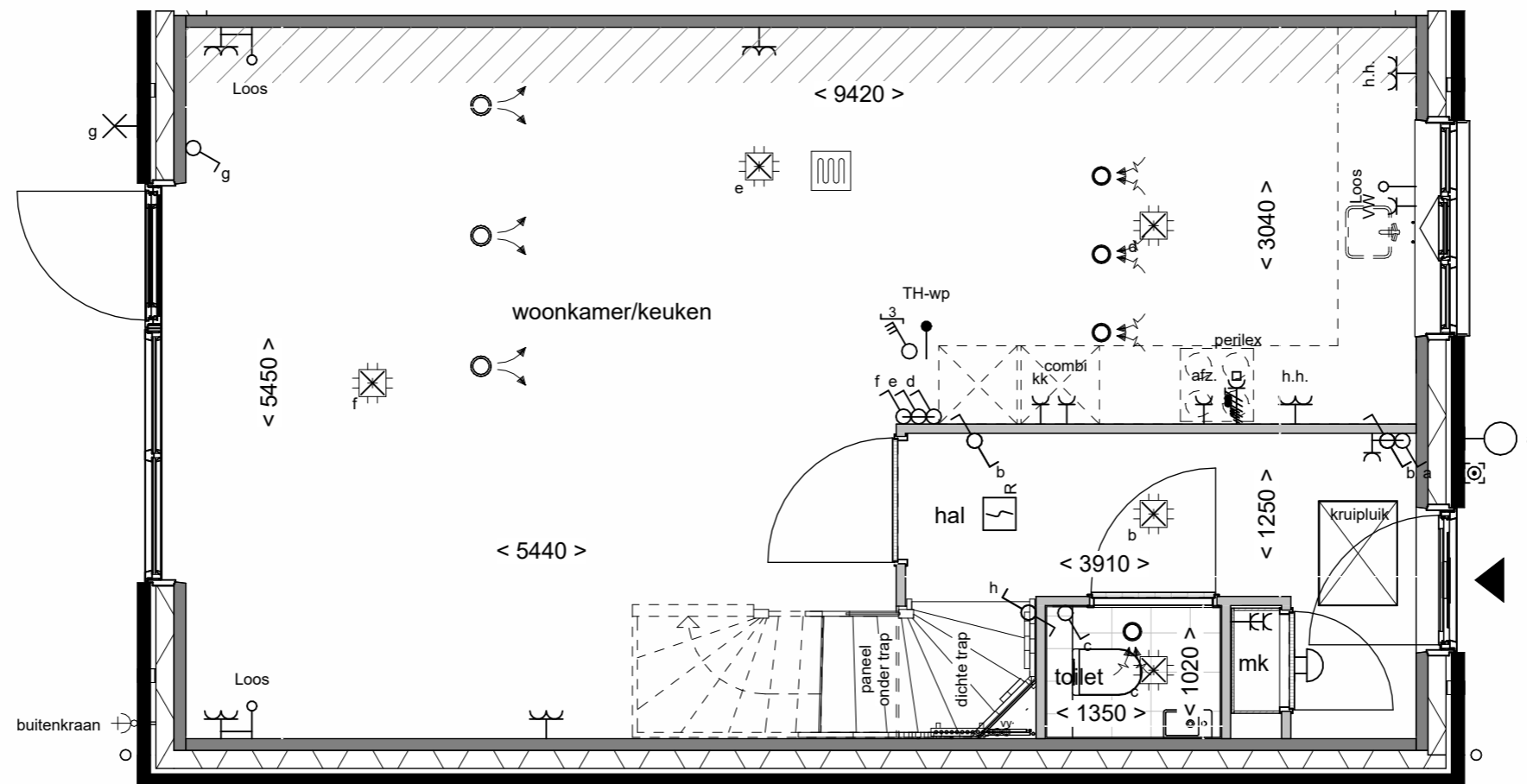

Achtergevel schaal 1:100



STEENBRUGGE
DEVENTER



VAN WIJNEN
vorstvrije
buitenkraan achter

Tekening: C57

Woningtype: -

Bouwnummer: 2.K.0.44

Optienummer: A3

Schaal: 1:50 / 1:100

Datum: 26-11-2024